

dyson ball animal

User manual

SV12 JN.00000 PN.000000-00-00
00.00.00 VERSION NO.01

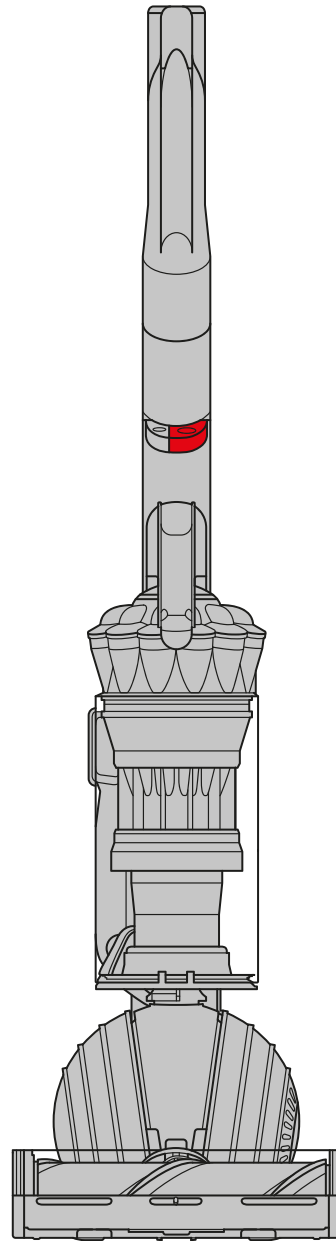

In the box
Getting started
Assembling your machine
Caring for your floors
Using your Motorbar™ cleaner head
Using your tools
Emptying your bin

Storing your machine
Clearing blockages
Clearing obstructions from your
Motorbar™ cleaner head
Washing your filters
Looking after your machine

In the box

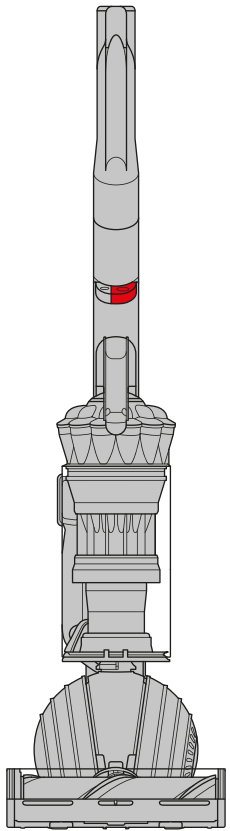

Vacuum cleaner

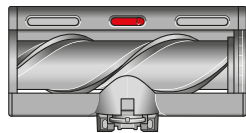

Motorbar™ cleaner head

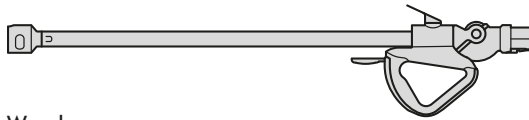

Wand

Some tools and accessories may not be included.

You can buy additional tools and accessories at www.dyson.com.



Combination tool
Two tools in one - brush and nozzle, for versatile cleaning around your home.

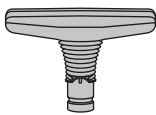

Stair tool
For vacuuming narrow or difficult-to-reach carpeted areas, such as stairs and corners.

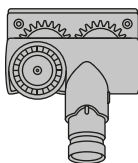

Tangle-free turbine tool
Only Dyson uses counter-rotating heads to remove hair from carpets and upholstery with no tangles.



Soft dusting brush
Enclosed in a skirt of soft nylon bristles for gentle, vacuum-assisted dusting of delicate objects and surfaces.

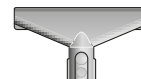

Fabric and mattress tool
Removes dust, dirt and allergens from mattresses and upholstery.

Getting started



Lean to clean
Lean handle back to start a clean. Leave upright to direct suction to the wand.

Power button
Press the power button to start cleaning.

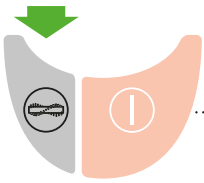

Brush bar control
Turn off the brush bar for delicate floors or deep pile rugs.

Ball technology
Easy to manoeuvre. Steers around furniture with a gentle turn of the wrist.

Motorbar™ cleaner head
De-tangling vanes automatically clear wrapped hair from the brush bar as you clean.

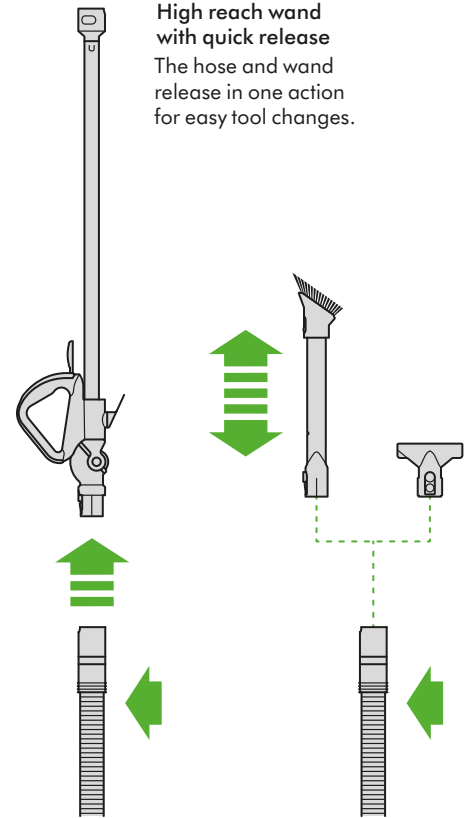

High reach wand with quick release
The hose and wand release in one action for easy tool changes.

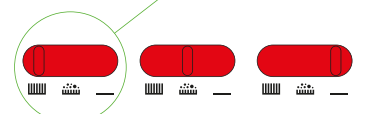
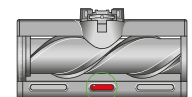
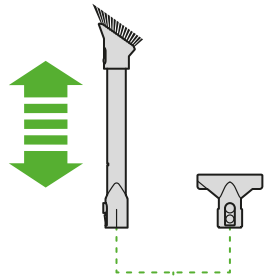

Variable suction control
Adjust the slider for the right suction for the right task: deep- and medium-pile carpets, low-pile carpets and large debris, and hard floors and ground-in dirt.

Assembling your machine

Fit the cleaner head

Lie your machine on its back.

Slide your Motorbar™ cleaner head into position on the front of the ball. Push upwards until the red button on the underside of your machine clicks securely in place.

Stand your machine upright.

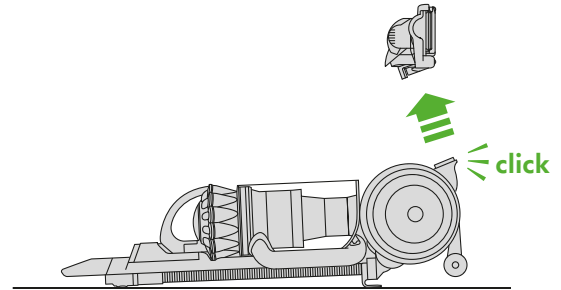

Fit the wand

Push the wand into the end of the hose until it clicks into position.

Slide the handle onto the top of your machine.

Slide the wand down into the hose.

Close the wand end cap.

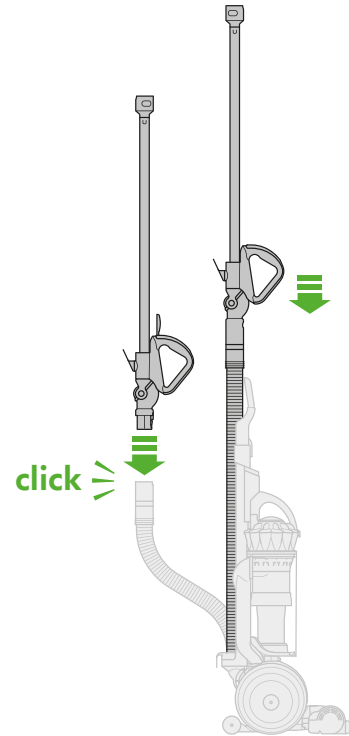

Fit the tool holder

Slide the tool holder into position on the side of your machine.

Fit your combination tool onto the holder.

Fit the Tangle-free turbine tool holder (optional)

If your machine is supplied with a Tangle-free turbine tool holder, clip this to the front of the handle, just above the power button.

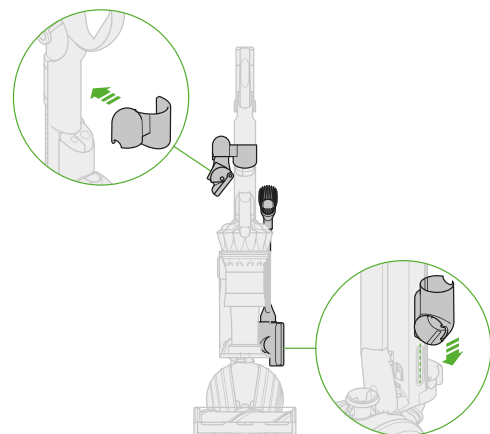

Wrap the cable around the top and bottom cable hooks and secure with the cable clip.

Caring for your floors

Check that the underside of the cleaner head or tool is clean and free from any objects that may cause damage.

Before vacuuming your flooring, rugs, and carpets, check the manufacturer's recommended cleaning instructions.

The brush bar on your machine can damage certain flooring. Some rug materials may fuzz if a rotating brush bar is used when vacuuming. If this happens, we recommend vacuuming without the motorised floor tool and consulting with your flooring manufacturer.

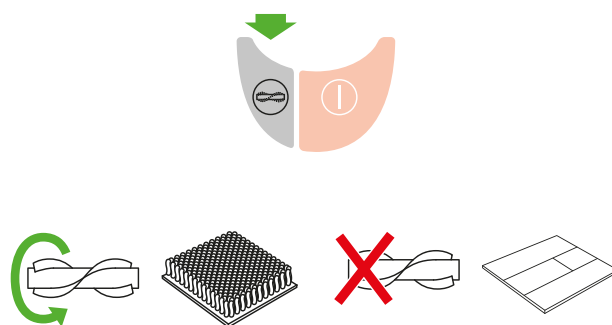

Using your Motorbar™ cleaner head

Your cleaner head has a motor-driven brush bar with suction control.

Check the manufacturer's recommended cleaning instructions for your flooring type.

Slide the suction control to suit your floor type. Select the right cleaning mode for the right task.

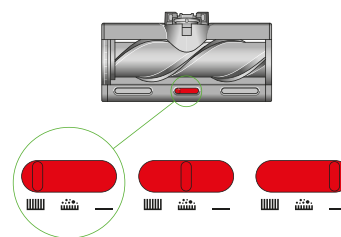

Position the slider to the left for use on deep- to medium-pile carpets, delicate flooring and rugs.



Position the slider in the center for low-pile carpets and large debris.



Position the slider to the right for hard floors and ground in dirt.



Using your tools

Attach to the wand

Open the cap on the handle and slide the wand upwards until both the wand and hose release from the machine.

Push the tool into the end of the wand.

Remove the tool from the wand

Remove the tool from the end of the wand.

Slide the handle onto the top of your machine.

Slide the wand down into the hose.

Close the wand cap.

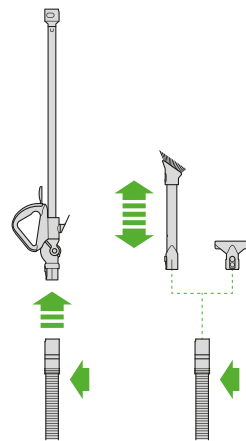

Attach to the hose

Open the cap on the handle and slide the wand upwards until both the wand and hose release from the machine.

Press the button on the end of the hose to release the wand.

Fit the tool into the end of the hose.

Remove from the hose

Remove the tool from the end of the hose.

Push the wand into the end of the hose until it clicks into position.

Slide the handle onto the top of your machine.

Slide the wand down into the hose.

Close the wand end cap.

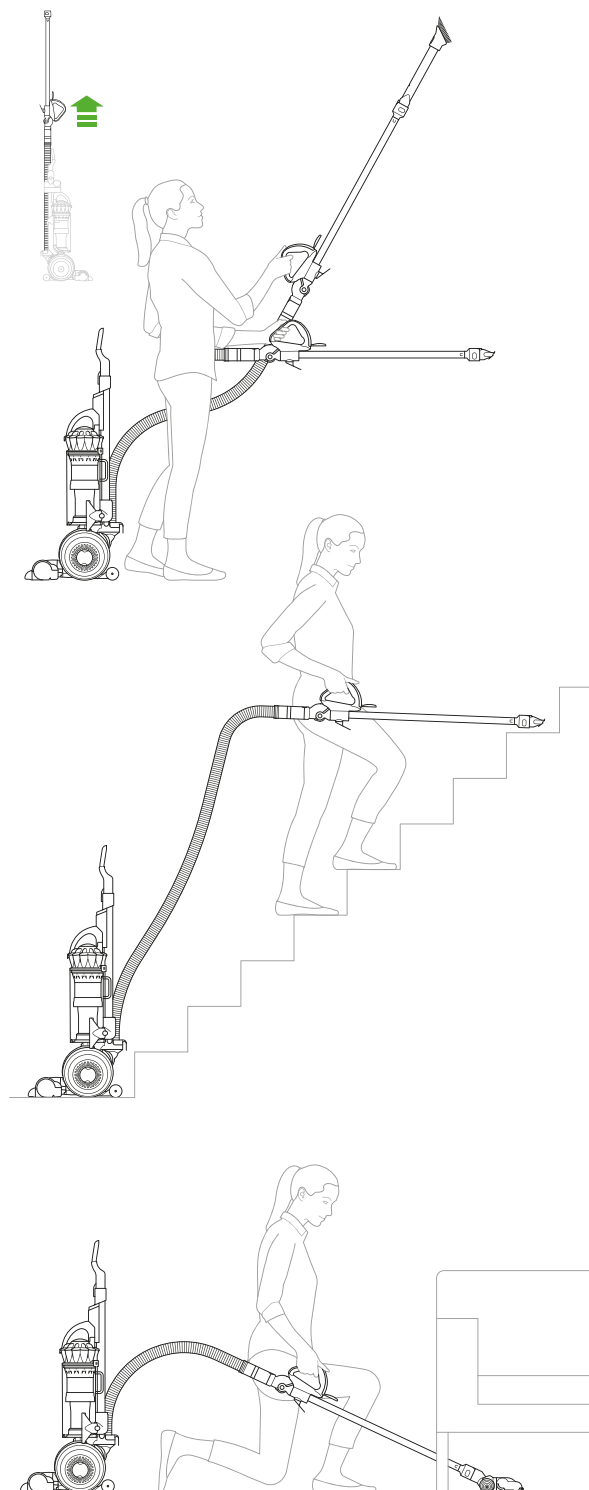

Emptying your bin

Empty as soon as the dirt reaches the MAX level – don't overfill. Using your machine when the dirt is above the MAX line may affect the performance and require more frequent filter washing.

Remove your bin

Turn off and unplug your machine.

Press the button on the bin handle to detach the bin from your machine.

Release the dirt

Hold your bin, with the bin base pointing down, over your rubbish container.

Firmly push the button on the bin handle, until the bin base opens.

Minimise dust contact

Cover your bin tightly in a dust proof bag while you empty. Remove your bin carefully, seal the bag tightly and dispose.

Refit your bin

Push the bin base up until it closes, clicking into place.

Position the bottom of your bin in position and then push the top into your machine until it clicks securely into place.

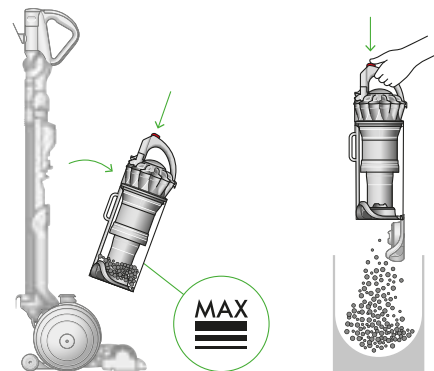

Storing your machine

Carry your machine using the bin handle.

Push your handle into the upright position.

Push your handle firmly forward and listen for two clicks to lock in upright position.

The stabiliser wheels will drop into position when the handle is locked in the upright position.

Clearing blockages

If any part of your machine becomes blocked, it may automatically cut out and the power will stop.

Unplug and leave your machine to cool before checking for blockages.



Remove cleaner head

Lie your machine on its front.

Push down the red button on the bottom of the ball and then slide your cleaner head down and off your machine.

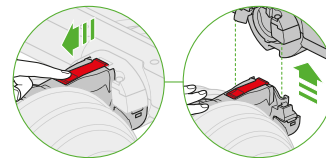

Check the wand

Open the cap on the handle and slide the wand upwards until both the wand and hose release from the machine.

Press the button on the end of the hose to release the wand.

Look through the wand to check for blockages.

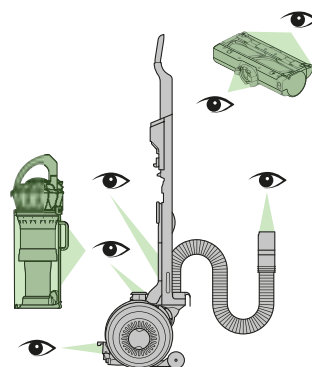

Check the hose

Open the cap on the handle and slide the wand upwards until both the wand and hose release from the machine.

Press the button on the end of the hose and remove the wand.

Press the button on the bin handle and remove the bin. Press the tab on the base of the hose to remove it from your machine.

Check for blockages in the hose, be careful of any sharp objects.

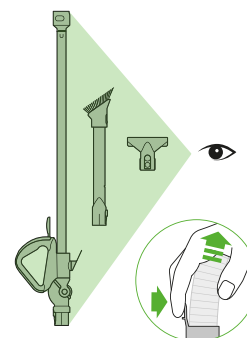

Check airways for blockages

Recline your machine and remove the outer cover of the ball.

Remove the cross-head screw and unhook the plastic access cover.

Check the airway for any blockages.

Replace the plastic cover by hooking it back into the slot and pushing it towards the filter. Fasten the cross-head screw and replace the outer cover on the ball.

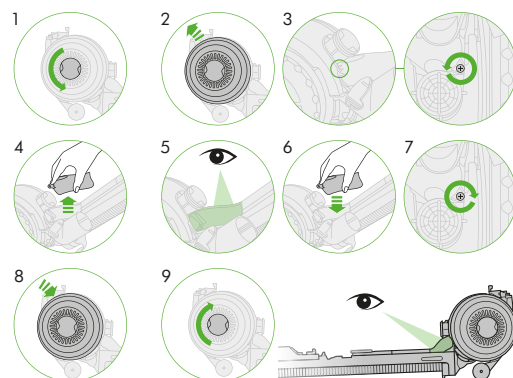

Reassemble your machine

Follow the assembly instructions to reassemble your machine.

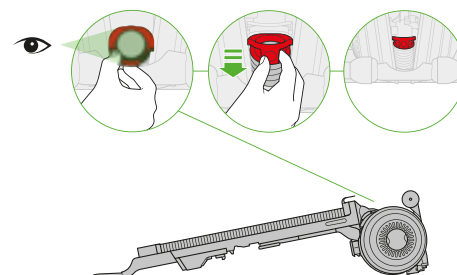

Clearing obstructions from your Motorbar™ cleaner head

Your Motorbar™ cleaner head doesn't have a washable brush bar. To maintain optimum performance, check your brush bar regularly and clear any obstructions.

Unplug and leave your machine to cool before checking for blockages.



Remove cleaner head

Lie your machine on its back.

Push down the red button on the bottom of the ball and then slide your cleaner head down and off your machine.

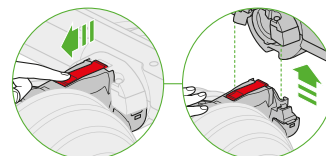

Remove your brush bar

Press the button on the back of the Motorbar™ cleaner head and push upwards 90° to release the end cap.

Pull the brush bar out of the cleaner head.

Remove debris from around the brush bar.

Be careful of any sharp objects when clearing blockages.

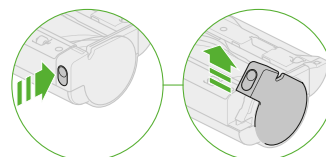

Replace your brush bar

Push the brush bar firmly back into the cleaner head.

Make sure the brush bar is pushed fully into the cleaner head. Rotate the end cap until it clicks back into the locked position.

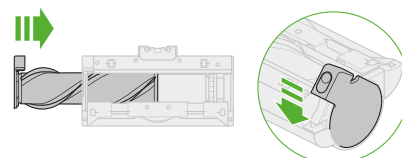

Fit the cleaner head

Slide your Motorbar™ cleaner head into position on the front of the ball. Push upwards until the red button on the underside of your machine clicks securely in place.

Washing your filters

Wash your filters at least once a month to maintain optimum suction power.

For more information and support videos for your machine go online:
www.dyson.com/support

Washing filter A

Remove your filter

Press the button on the bin handle to detach the bin from your machine.

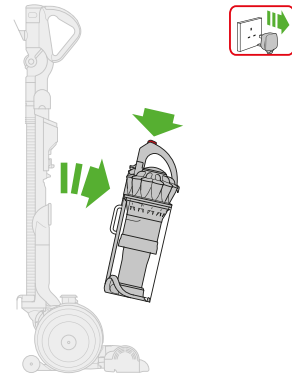

Wash your filter

Push up the catch on the front of the bin handle and lift out the filter.

Only wash the filter with cold water. Hold the open end of the filter under a running tap, until the water runs clear.

Turn the filter upside down and tap it to remove excess water.

Run water over the outside of the filter until the water runs clear.

Squeeze and twist with both hands to make sure the excess water is removed.

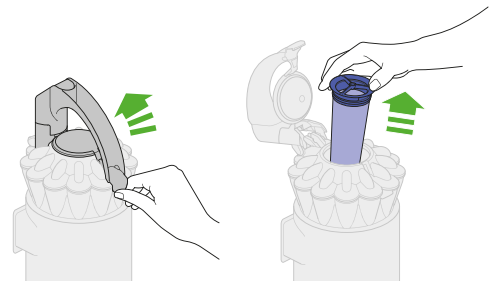

Dry your filter

Squeeze the excess water out of your filter.

Leave your filter to dry for at least 24 hours in a well-ventilated, warm place.

Don't dry your filter in a tumble dryer, microwave or near a naked flame.

Important: your filter must be completely dry before you put it back into the machine. Your machine could be damaged if used with a damp filter.

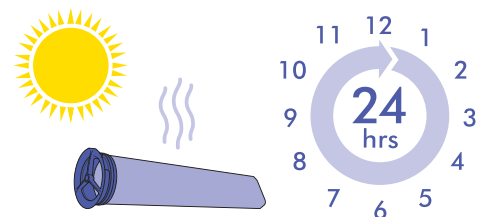

Refit your filter

Drop your filter back into your machine. Close the handle and make sure it clips into place.

Place the base of your bin onto your machine and then push the top into position until it clicks.

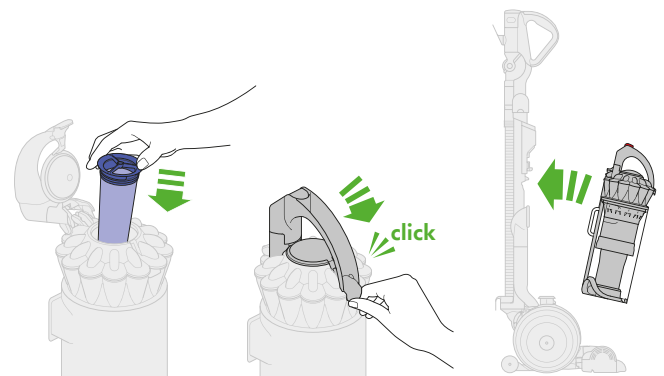

Washing filter B

Remove your filter

Lie your machine on its side with the side of the ball housing the filter facing upwards.

Turn the lock in the centre of the ball until the filter cover is released.
Lift off the filter cover.

Twist the filter counter-clockwise until it is released and lift it off your machine.

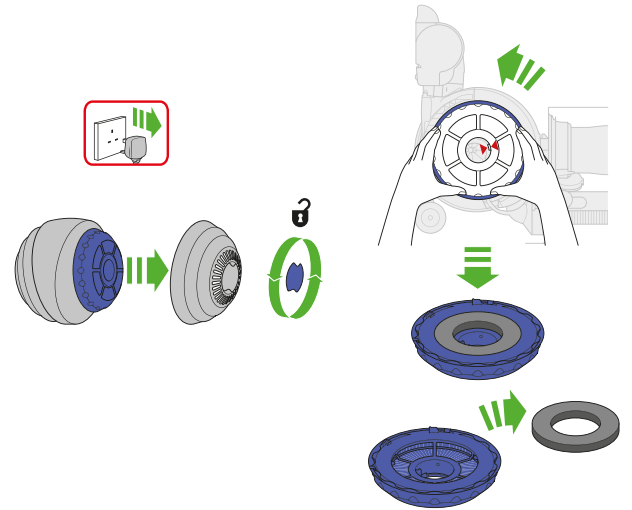

Wash your filter

Remove the inner part of the filter.

Wash the outer filter in a rotating motion.

Wash the inner foam part of the filter, taking care not to squeeze it.

Repeat until the water runs clear.

Tap the outer filter to remove excess water.

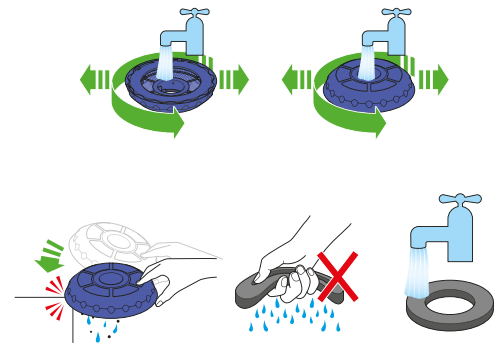

Dry your filter

Leave both parts of your filter to dry for at least 24 hours in a well-ventilated, warm place.

Don't dry your filter in a tumble dryer, microwave or near a naked flame.

Important: your filter must be completely dry before you put it back into the machine. Your machine could be damaged if used with a damp filter.

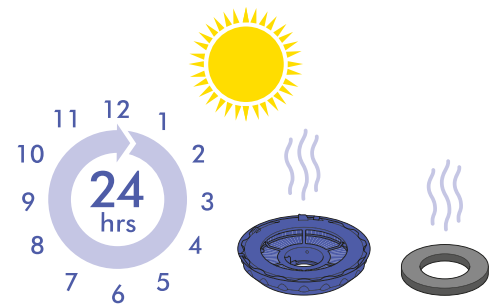

Refit your filter

Refit the inner part of the filter and then place the filter back onto the ball.

Twist the filter clockwise until it clicks into position.

Refit the filter cover and turn the lock until it clicks securely into the closed position.

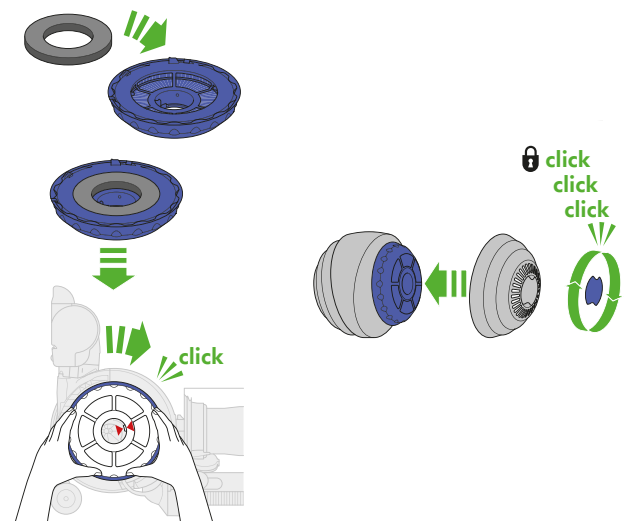

Looking after your machine

To always get the best performance from your machine, it's important to clean it regularly and check for blockages.

Look after your machine

If your machine is dusty, wipe with a damp lint-free cloth.

Check for blockages in the cleaner head, tools and main body of your machine.

Wash your filter regularly and leave to dry completely.

Don't use detergents or polishes to clean your machine.

Your serial number

You can find your serial number on your machine, behind the bin. Use your serial number to register your machine.