

# dyson 360 vis nav

## User manual

SV12 JN.00000 PN.000000-00-00  
00.00.00 VERSION NO.01

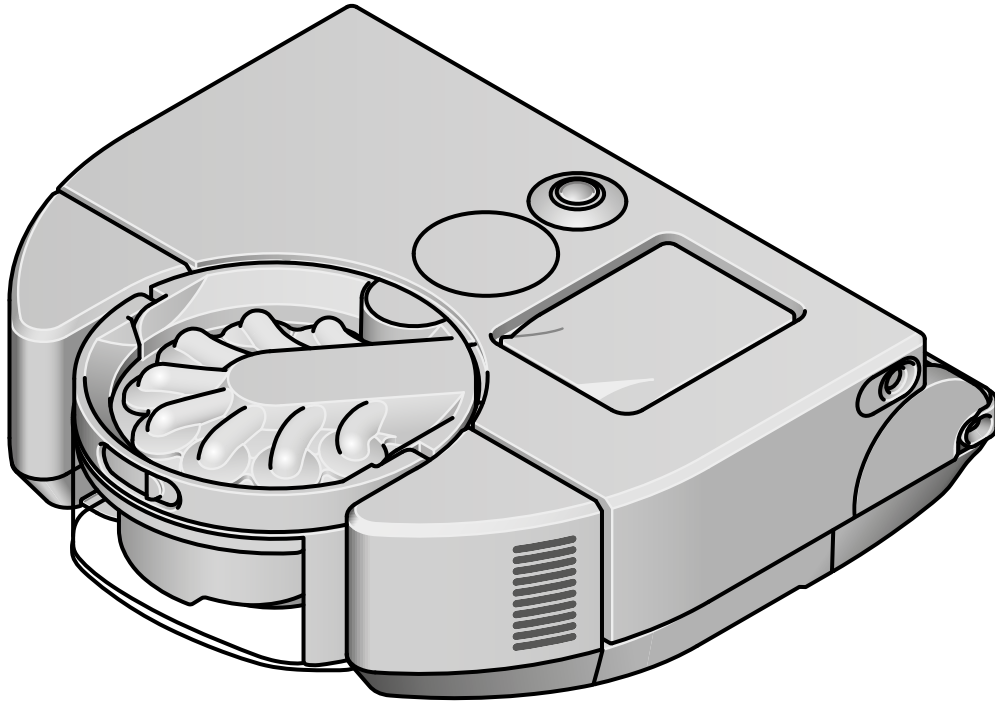

---

### Contents

Getting started

Downloading the MyDyson™ app

Connecting to Wi-Fi

Setting up your dock

Setting the language

Preparing to clean

Starting a clean

Mapping your home

Zoning your home

Scheduling and reviewing cleans

Looking after your robot

Emptying your bin

Washing your filter

Maintaining your brush bar

Cleaning your camera lens and sensors

Alerts

Resetting and upgrading software

# Getting started

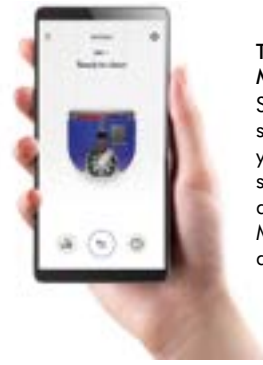

## Tailor your robot with the MyDyson™ app

Set your robot's behaviour to suit your lifestyle. Have it learn your home's layout, so you can schedule it to clean when, where and how you want – only with the MyDyson™ app. If you haven't already, download it now.

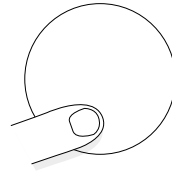

### LCD touchscreen

LCD touchscreen lets you see real-time feedback and choose between modes.

Swipe through menus, tap to select, press and click to confirm your selection.

### Power modes

Four modes, to clean your way.



### Auto mode

Analyses dust levels, automatically optimising suction power.



### Boost mode

Boosts suction to clean ground-in dirt and pet hair. Extra power with less run time.



### Quiet mode

Reduces noise for peaceful areas – and longer run time.



### Quick mode

To stay on top of every day cleans in open areas. Your robot won't deep clean edges and corners.



### Edge cleaner

Automatically redirects suction to pick up dust and debris right up to the wall.

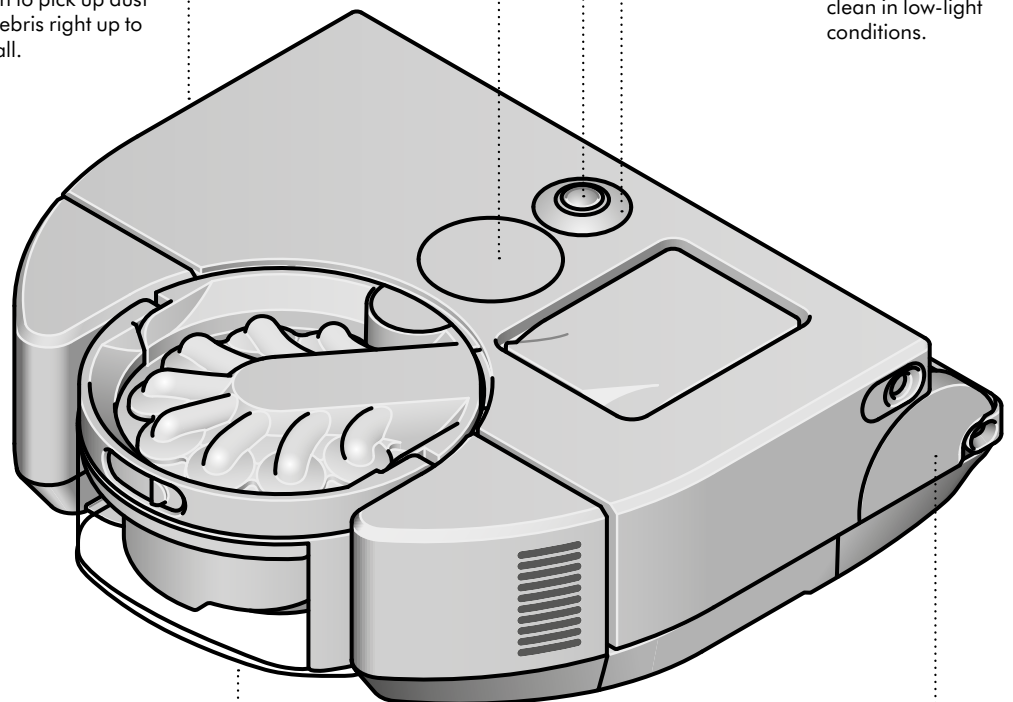

### Intelligent navigation

26 sensors. 360° panoramic vision. Allowing the robot to systematically navigate and adapt.

### LED light ring

Eight LEDs allow the robot to clean in low-light conditions.

### Piezo sensor

Detects changes in dust levels, automatically increasing suction power where needed.

### Triple-action brush bar

Extends the full width of the machine to clean edge-to-edge. Black anti-static carbon fibre filaments extract fine dust from hard floors, stiff nylon bristles remove ground-in dirt from carpets, and soft woven nylon captures large debris.

# Downloading the MyDyson™ app

Control your robot – wherever you are. You can start cleaning, check your robot's progress or troubleshoot a problem. If you haven't already, download the app now for extra features and the latest updates.

Download the MyDyson™ app from the App Store or Google Play. Open the app and follow the on-screen instructions to create a new account.



Apple and the Apple logo are trademarks of Apple Inc., registered in the U.S. and other countries. App Store is a service mark of Apple Inc., registered in the U.S. and other countries. Google Play and the Google Play logo are trademarks of Google Inc.



---

## Connecting to Wi-Fi

### Download the MyDyson™ app

Choose your robot and follow the instructions on the MyDyson™ app to get connected.

### Connection problems

Your robot accesses the Dyson cloud through your home Wi-Fi network. If you have a problem connecting, your robot can help get you back online.

Go into the settings menu on your robot's LCD touchscreen and press and click the Wi-Fi icon. Your robot will indicate what Wi-Fi network it is connected to and the signal strength.

If your robot has failed to connect, press and click on 'Check connection' to diagnose the problem. If your robot is not connected to your Wi-Fi router or the internet, try the following:

Move your robot close to your Wi-Fi router, then turn your robot off and on again to reconnect.

Check other devices on the same Wi-Fi network can access the internet. If not, turn your router off and on again. If the problem persists, contact your internet service provider.

If you have changed your Wi-Fi network settings, you may need to re-connect your robot. Follow the 'Change or add new Wi-Fi network' instructions to re-connect.

If your robot is not connected to the Dyson cloud, try connecting to your robot again later.

### Changing or adding a new Wi-Fi network

Open the settings menu in the MyDyson™ app and scroll down to 'Add new Wi-Fi'.

Follow the on-screen instructions to add a new Wi-Fi network.

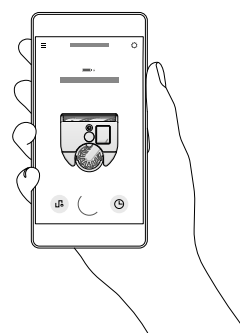
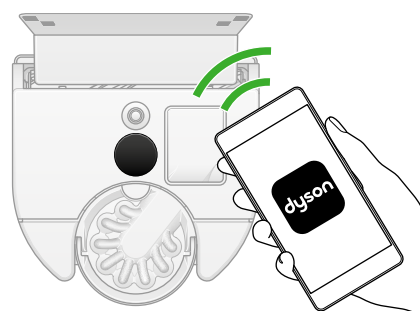

# Setting up your dock

## Choose a location

It's important that you locate the dock carefully, as the robot will need clear access to it.

The dock should be located against a wall, on a level surface, close to a mains power supply. Make sure the position is out of bright sunlight and not obscured under a table or other furniture.

The dock also needs to have at least 50 cm of clear space around the sides and at least 1m in front.

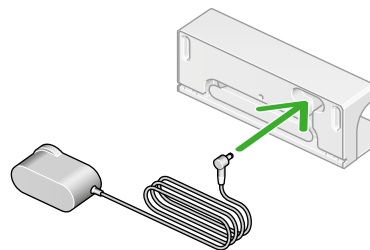

## Assemble your dock

Plug the charger connector in to the back of the dock and connect to the mains power supply. A blue LED will light up when power is connected.

Wrap any excess cable around the cable tidy on the back of the dock.

Align the back panel of the dock with the floor section and press until it clicks into place. The back panel is removable if you need to dismantle your dock.

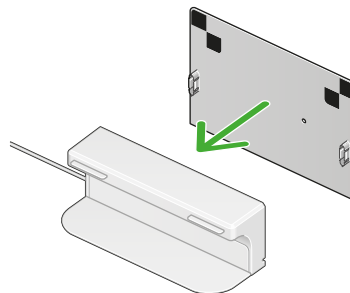

## Plug in and charge

Place your robot on the dock. Your robot will turn on and the LCD touchscreen will light up.

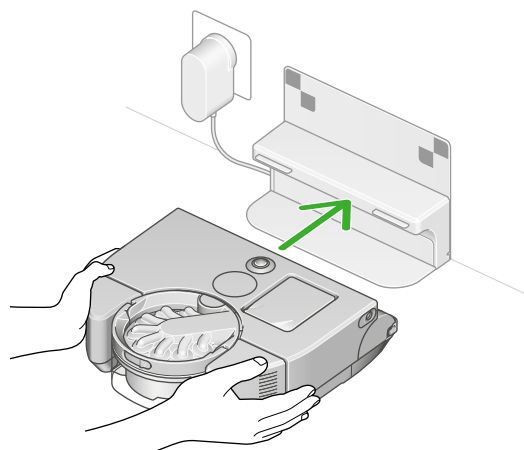

## Standby power

To save energy when it's on the dock, your robot will go into standby mode and the LCD touchscreen will dim.

You can activate your robot by pressing the LCD touchscreen, or by using the app or voice control.

## Powering off

If you need to turn off your robot's power, take it off the dock. Press and hold the screen until the Power off menu appears on the screen. Press and click the LCD touchscreen to confirm.

Place your robot on the dock to turn the power on again.

# Setting the language

When you first set up your machine, you'll need to select the language your robot will use.

Scroll up and down, through the languages.

When the language you'd like is highlighted, press and click the LCD touchscreen to confirm your selection.

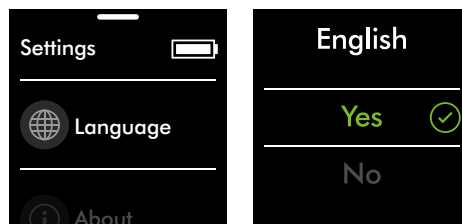

---

## Preparing to clean

### Caring for your floors

Check that the underside of your robot is clean and free from any objects that may cause damage.

Before vacuuming your flooring, rugs, and carpets, check the manufacturer's recommended cleaning instructions.

The brush bar on your robot can damage certain carpet types and floors. Some carpets will fuzz if a rotating brush bar is used when vacuuming. We recommend blocking access or creating a 'No brush bar' area in the MyDyson™ app.

### Prepare your home

Remove thin rugs or loose objects that your robot may suck up. Tidy small items such as shoe laces or thin cables that your robot won't detect and may get tangled in the brush bar.

Clean any liquid spills or sharp items that could damage your robot.

Open all doorways and clear away any furniture or items that are not permanent so that your robot can access all areas.

Clear away any obstructions from drops or steps.



# Starting a clean

Use the MyDyson™ app to start your clean or press and click the LCD touchscreen. You can start your clean from the dock or pick up your robot and move it to a specific position.

## Start from the dock with the MyDyson™ app or voice control

Start the clean using either the MyDyson™ app or with voice control that you have set up.

Choose to use a customised clean of an individual room, a selection of rooms, or clean all accessible areas. Your robot will clean following your mapping, zoning and restriction settings in the MyDyson™ app.



## Start from the dock

Start the clean by choosing your power mode then press and click the LCD touchscreen or from the app, to start the clean. Your robot will clean all areas that are accessible.

Your robot will return to the dock to charge when the battery is low.

Once your robot has charged, it will automatically continue its clean.

## Starting a clean off the dock

To clean a specific area or a different level, start your robot away from the dock.

Your robot will clean all the accessible space it can reach on a single charge.

Your robot won't return to the dock to charge, when the battery is low, but return to its starting point.

You won't be able to start your clean from the MyDyson™ app and your robot won't obey room boundaries or restrictions.



# Mapping your home

## Unlock intelligent features with the MyDyson™ app

Your robot works in tandem with the MyDyson™ app to intelligently navigate and deep clean your home. Easily connect to see where it's cleaned, create zones and customise your robot's behaviour.

Creating a map of your home with the MyDyson™ app lets your robot learn the layout. This gives you more control over where and how your robot cleans areas of your home.



## Prepare to map your home

Before mapping, it's a good idea to tidy up any loose objects from the floor, open internal doors and remove any items that may be moved between cleans. Place your robot on the dock and you can start mapping.

Building a complete map can take time, and depends on the size of your home (100 sq m may take approximately 90 minutes). During the mapping process, leave your robot to create your map. It will return to the dock by itself when mapping is complete.

## Create a map

Your robot follows an optimised route to systematically clean your home, with the brush bar and suction turned off to minimise the time taken to map. For best results, avoid interrupting your robot while it's mapping.

Your robot needs a complete and accurate map of your home, so if there are any problems during mapping, it's better to start again.



## Multiple floors

If your home has more than one floor level, you can create a map for each storey or level of your home.

When you clean on a different level of your house, you'll need to move your robot's dock to each level and start each mapping mission from the dock. Check [www.dyson.com](http://www.dyson.com) for the option to purchase additional docks.

# Zoning your home

Once you've created a map, follow the instructions on the MyDyson™ app to create zones.

Divide your map into zones. Once you divide your map into different zones, you can choose when and how each zone is cleaned.

Tap on the map to add zone dividers.

You may want to use room boundaries so that you can customise the clean for each room.



## Customising cleans

Pick a zone or selection of zones to clean.

Choose a power mode for your selected zone.

Your robot will clean zones in the order that minimises the time taken to complete the clean.

## Adding restrictions

Using the MyDyson™ app, you can select areas that your robot needs to avoid, turn off the brush bar or avoid climbing in that area.

### Avoid areas

You can select areas on your map for your robot to avoid. This can be used in areas with cables, clothing or toys, where your robot might get stuck. You can also avoid entire rooms, such as the bathroom.

### No brush bar

Your robot will vacuum in this area with the brush bar turned off. This is useful where there are delicate floors or long-pile rugs.

### No climb

Your robot will avoid climbing in areas where obstacles may cause it to get stuck, such as furniture with pedestals or low level items.



# Scheduling and reviewing cleans

## Scheduling cleans

Use the MyDyson™ app to schedule cleans for times when you're not at home, or clean high traffic areas more frequently.

## Reviewing cleans

Use the MyDyson™ app to see a map of where your robot has cleaned.

Your robot will update its map at the end and periodically during a clean.

You can use the map to see where your robot has got stuck during a clean, then use this as a guide to add restrictions.

Your map will indicate the levels of dust detected during the clean, you may want to clean areas with higher dust more often.



# Looking after your robot

For optimum performance, regularly clean your robot and check for obstructions.

## Look after your robot

If your robot is dusty, wipe with a dry lint-free cloth.

Don't use detergents or polishes to clean your robot.

Keep your robot's software up to date with the MyDyson™ app.

## Wash your filter

Wash your filter regularly and leave to dry completely.

## Check airways for blockages

Check your robot regularly for blockages in the airways. Remove the bin and check for debris in the airway behind it.

## Check brush bar for obstructions

Check the brush bar regularly and remove any threads, hair and any other debris that may cause an obstruction.

## Check wheels for obstructions

Turn your robot over on a soft surface to protect the lens. Check that the wheels are clear of any threads, hair or other debris that may cause an obstruction.

## Clean optics obstructions

Regularly check that your camera and sensors are clean and free from any dirt or smears. Use a soft, dry, lint-free cloth to clean the optics.

## Look after your battery

Your machine won't operate or charge if the ambient temperature is below 5°C (41°F). This is designed to protect both the motor and battery.

## Register your robot

You'll need your serial number, located behind the bin.

For more information and support videos for your machine go online: [www.dyson.com/support](http://www.dyson.com/support)

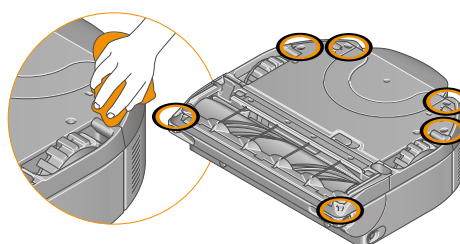
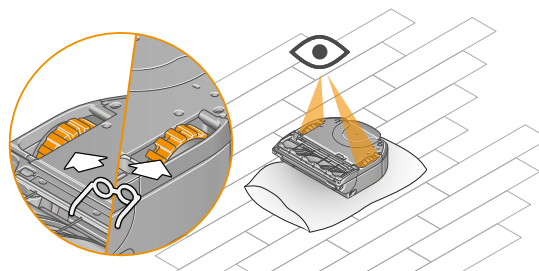
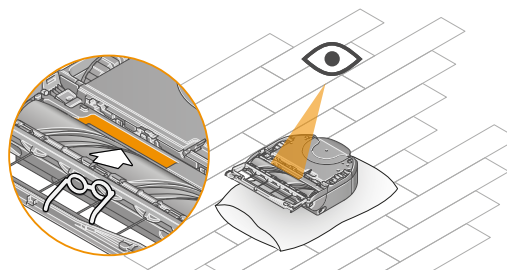
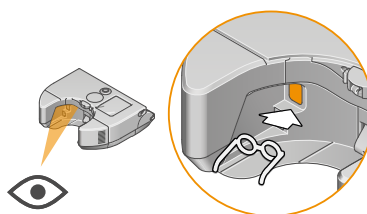

# Emptying your bin

Empty your bin as soon as the dirt reaches the MAX level

## Remove your bin

Press the bin removal catch on the top of your robot and lift your bin away.  
Use the handle to carry your bin.

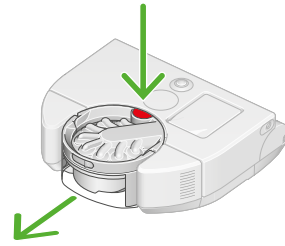

## Release the dirt

Hold your bin over a rubbish container, pointing downwards.

Push the cyclone release button on the handle.

Your bin will slide down, cleaning the shroud as it goes, the bin base will open, releasing the dirt.



## Minimise dust contact

Cover your bin tightly in a dustproof bag while you empty. Remove your bin carefully, seal the bag tightly and dispose.

## Close the bin

Push the bin base upwards until your bin and bin base click into place.

Push your bin back into place, make sure it clicks securely back into your robot.

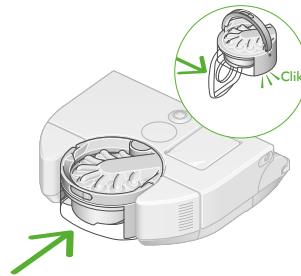

## Cleaning your bin

Your bin isn't dishwasher safe and using detergents, polishes or air fresheners to clean it isn't recommended, as it could damage your robot.

Empty your bin and press the bin empty catch. This is located under the cyclone, on the bin runner.

Slide your bin off the runner and put the cyclone to one side.

Only use a damp, lint-free cloth to clean your bin.

Make sure that your bin and seals are completely dry before replacing.

# Washing your filter

Wash your filter at least once a month to maintain optimum suction power.

**Important:** your filter must be completely dry before you put it back into the machine. Your machine could be damaged if used with a damp filter.

The filter unit housing your washable filter can be wiped with a damp, lint-free cloth to remove any dirt or dust.

For more information and support videos for your machine go online: [www.dyson.com/support](http://www.dyson.com/support)

## Remove your filter

Press the filter unit on the top of your robot and it will pop up. Lift it out of the robot and remove the filter inside.

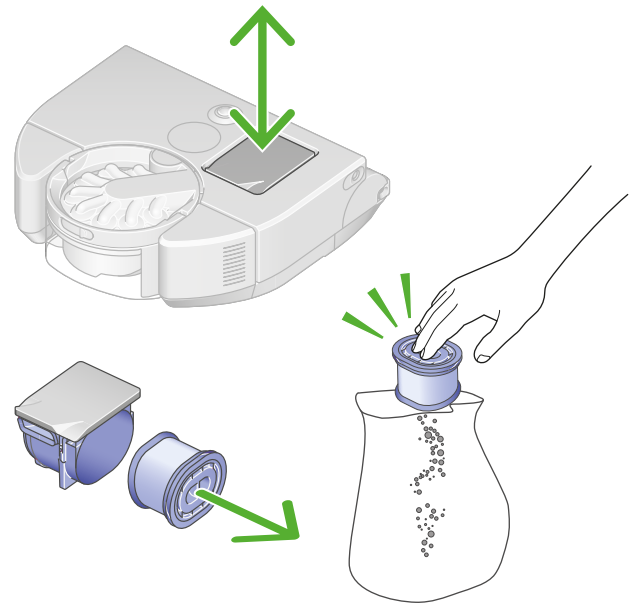

## Tap your filter

Before washing your filter, tap it gently over a bin to remove any loose dust and debris.

## Wash the inside

Wash with warm, running tap water. Don't use detergent, or wash it in a dishwasher or washing machine.

Place your hand over one end of your filter.

Fill the filter with warm tap water.

Place your hand over the open end of the filter and shake it firmly to remove trapped dirt and debris.

Repeat these steps until the water runs clear.

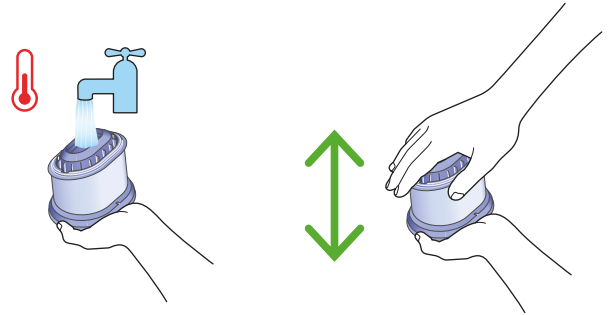

## Wash the outside

Wash with warm, running tap water – gently rubbing your filter with your fingers to remove the dirt.

Repeat until the water runs clear.

## Shake out the water

Empty the filter and shake it firmly to remove excess water.

Shake with the filter in both an upward and downward position.

Keep shaking it until there's no water coming from the filter.

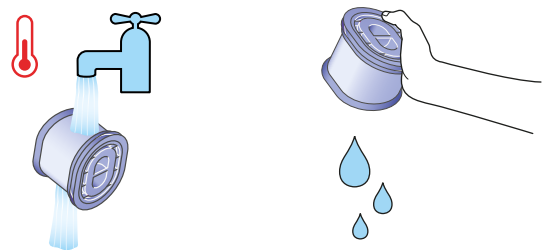

## Dry your filter

Place your filter on its side and leave to dry for at least 24 hours in a well-ventilated, warm place.

Don't dry your filter in a tumble dryer, microwave or near a naked flame.

**Important:** your filter must be completely dry before you put it back into the machine. Your machine could be damaged if used with a damp filter.

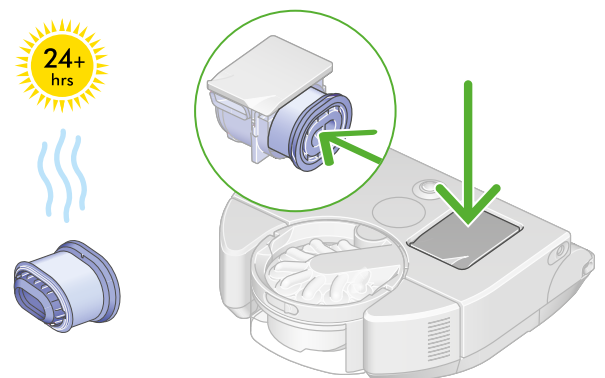

# Maintaining your brush bar

To maintain optimum performance, check and remove hair and debris from your brush bar at least once a month.

## Remove your brush bar

Don't put any part of your machine in a dishwasher or use detergents, polishes or air fresheners.

Turn your robot over and place it on a soft surface.

Lift the red brush bar cover lever on the base of your robot and then press the red brush bar release button.

Slide the brush bar out of your robot and remove any threads wrapped around the brush bar. Remove debris from the brushbar recess, including any threads wrapped around the rotating parts.

Pull the silver end cap from the brush bar and remove any threads from the recess. Don't wash the end cap.

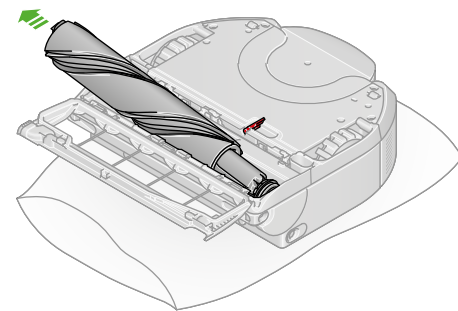
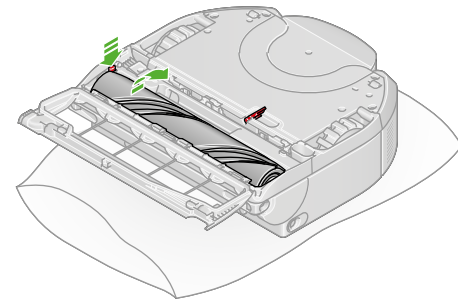
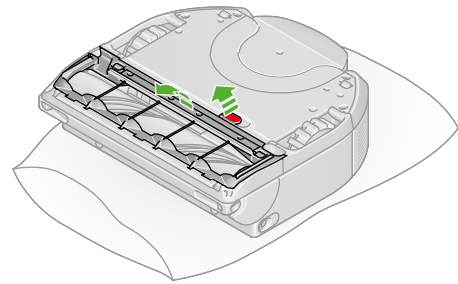

## Wash and dry your brush bar

If your brush bar needs washing, hold your brush bar under running water and gently rub to remove any lint or dirt.

Remove as much excess water as possible. Run your hand down the length of the brush bar to squeeze out the water.

Stand your brush bar upright. Leave to dry completely for at least 24 hours.

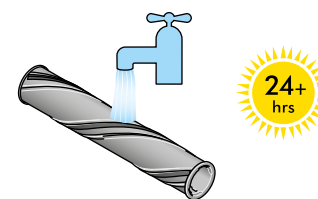

## Replace your brush bar

Before replacing, check that your brush bar is completely dry.

Push the end cap back onto the brush bar. Slide the brush bar back into your robot, push down on it until the release button pops back up.

Close the brush bar cover and push the lever down to lock the cover in place.

# Cleaning your camera lens and sensors

To maintain optimum performance, regularly check and clean dust, debris and smears on the sensors.

We recommend that you check and clean your robot's sensors at least once a month.

Use a soft, dry, lint-free cloth to wipe the top sensors and camera lens. Do not use cleaning fluids, liquids or sprays of any kind. Turn your robot over and place on a soft surface. Use the same cloth to wipe the sensors on the bottom of the machine.

For more information and support videos for your machine go online: [www.dyson.com/support](http://www.dyson.com/support)

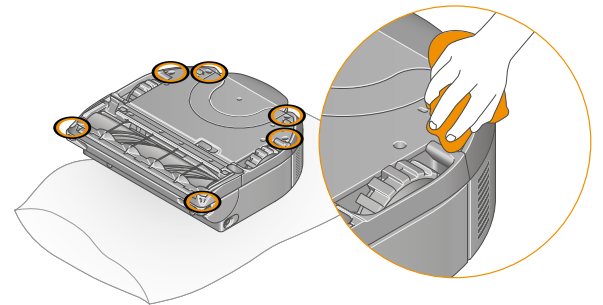
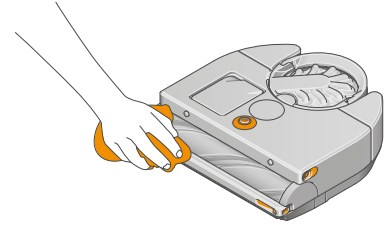
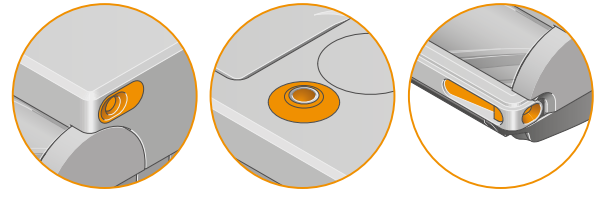

# Alerts

Icons will appear on the LCD touchscreen and in the MyDyson™ app to alert you that your robot needs your attention. Follow the instructions on the MyDyson™ app to clear the alert.

If you're unable to clear the alert, call the Dyson Helpline.

## **Airways blocked**

Your robot has detected a blockage in the airways, that may require the bin to be emptied.

Empty your robot's bin following the instructions in the 'Emptying your bin' section of this manual.

To clear a blockage, follow the instructions in the 'Looking after your robot' section of this manual.

## **Ambient temperature too low**

Your robot's internal temperature is too cold to clean. Put your robot back on the dock and start the next clean once it has warmed up.

## **Battery low. Place on dock.**

Put your robot on the dock to charge.

## **Battery not detected**

Check your battery is fitted correctly.

## **Bin not detected**

Check bin is fitted correctly. Your robot won't clean if the bin is missing or incorrectly fitted.

## **Brush bar stuck**

The brush bar has stopped spinning. Lift the robot and check that there are no obstructions. Follow the 'Maintaining your brush bar' instructions to remove the brush bar.

Set up a restriction in the MyDyson™ app if this alert continues to happen in a specific area of your home.

## **Check bin level**

Check your robot's sensors for threads, dust or smears, and clean following the instructions in 'Cleaning your camera lens and sensors'.

## **Drop sensors obscured**

Check your robot's drop sensors for threads, dust or smears, and clean following the instructions in 'Cleaning your camera lens and sensors'.

## **Edge cleaner stuck**

Check there isn't any dust or debris blocking the edge cleaner. Remove the obstruction, press and click the LCD touchscreen to resume the clean.

Set up a restriction in the MyDyson™ app if this alert continues to happen in a specific area of your home.

## **Filter not detected**

Check filter is correctly fitted. Your robot won't clean if the filter is missing or incorrectly fitted.

**Optics obscured**

Check your robot's camera and sensors for dirt, dust, fingerprints and smears, and clean following the instructions in 'Cleaning your camera lens and sensors'.

**Place on dock**

Your robot has a problem and needs you to place it on the dock.

Go into Settings on the MyDyson™ app. Check your robot's software is up to date and automatic upgrades are enabled.

**Robot lifted**

Your robot has detected that it has been lifted, or cannot move away from a drop. Place your robot on the floor, away from any drops, press and click the LCD touchscreen to resume the clean.

Set up a restriction in the MyDyson™ app if this alert continues to happen in a specific area of your home.

**Robot moved**

Your robot has detected that it has been moved. Place your robot on the floor, away from any drops, press and click the LCD touchscreen to resume the clean.

**Robot stuck**

If your robot is unable to move, pick it up, move it away from any obstruction. Press and click the LCD touchscreen to resume the clean.

Set up a restriction in the MyDyson™ app if this alert continues to happen in a specific area of your home.

**Robot temperature too high**

Your robot's internal temperature is too hot to clean. Put your robot back on the dock and start the next clean once it has cooled down.

**Routine check**

Your robot needs you to do a routine check of its systems.

Check your robot's camera and sensors for dirt, dust, fingerprints and smears, and clean following the instructions in 'Cleaning your camera lens and sensors'.

Lift the robot and check that there are no obstructions around its brush bar.

Follow the 'Maintaining your brush bar' instructions to remove the brush bar.

**System error detected**

Your robot has detected a system error.

To power off, press and hold the screen until the Power off menu appears on the screen. Press and click the LCD touchscreen to confirm.

Place your robot on the dock to turn the power on again.

Go into Settings on the MyDyson™ app. Check your robot's software is up to date and automatic upgrades are enabled.

**Wash filter**

Your robot has detected a blockage in the airways, that may require the filter to be washed.

Empty your robot's bin following the instructions in the 'Emptying your bin' section of this manual.

To clear a blockage, follow the instructions in the 'Looking after your robot' section of this manual.

If that does not resolve the issue, then follow the instructions in 'Washing your filter' section of this manual.

**Wheel stuck**

Lift your robot and check for any obstructions or items that have become entangled round the wheels.

Clear any obstruction following the instructions in the 'Looking after your robot' section of this manual.

Set up a restriction in the MyDyson™ app if this alert continues to happen in a specific area of your home.

**Unable to return to dock**

Your robot has been unable to return to its dock.

Your robot may have become boxed in by obstacles, ensure that its path back to the dock is not obstructed.

Check your robot's sensors for dust or threads and clean following the 'Cleaning your camera lens and sensors' section of this guide.

Your robot has its own lighting but this may not be sufficient in extremely dark conditions. Keep lights on in the areas to be cleaned.

Go into Settings on the MyDyson™ app. Check your robot's software is up to date and automatic upgrades are enabled.

**Unable to dock**

Your robot has been unable to dock.

Check your dock is set up correctly by following the 'Setting up your dock' section in this manual.



# Resetting and upgrading software

## Changing ownership

When you first connect your robot to the MyDyson™ app, you automatically become its owner. Your personal data, such as Wi-Fi settings, cleaning schedules and maps are linked to your account.

If you want to add another user, they should download the app and follow the instructions. They'll have the option to be a user or owner.

Owner – has full control of the data and users.

User – only has access to the functions available in the app and robot.

If you want to change ownership, or if a new user wants to take full ownership of the robot, the robot will be removed from the original owner's account. A notification of change of ownership will be sent to the original owner.

## Removing and resetting

To remove your robot from the app and remove your personal data, such as maps, from the MyDyson™ cloud, go into the Settings menu on the app and remove your robot.

To erase data from your robot, go to Settings on the LCD touchscreen menu, select 'Erase Data', press and click to confirm. This will erase personal data stored on the robot, such as Wi-Fi passwords, and return your robot to its factory settings.

## Upgrading software

To get the best experience from your robot and to access all the latest features, it's important that your Robot's software is up to date. We recommend you use Auto updates.

## Automatic updates

Open the Settings menu in the MyDyson™ app and scroll down to Software. Slide Auto update software to On.

When an update becomes available for your robot, it'll automatically download and install at the next available opportunity (when the robot is inactive, on the dock and connected to Wi-Fi).

An update screen will be displayed on your robot. Don't interrupt the update until it has completed. Removing the battery during an update may cause irreparable damage. We recommended you don't press and hold the screen during an update.

When the update is complete, the LCD touchscreen will return to the Power mode screen and your robot is ready to use.

## Manually update with a USB stick

Your robot's software can be updated using a USB stick if a Wi-Fi network isn't available.

You'll need to use a USB stick formatted to FAT32 with at least 1 GB free space.

The latest software update and release notes can be found on [www.dyson.com/support](http://www.dyson.com/support).

This software update should be the only item saved on to the USB stick.

Some web browsers may display the file in the browser instead of prompting you to download it. Follow your browser's process for saving the file onto your USB stick.

Remove the bin and insert the USB stick into the port behind the bin. Replace the bin and place your robot on the dock, making sure it's powered. Select 'Update with USB' from the Settings menu on the LCD touchscreen.

Remove the bin and insert the USB stick into the port behind the bin. Select 'Upgrade' from the menu on the LCD touchscreen.