

ASSEMBLY

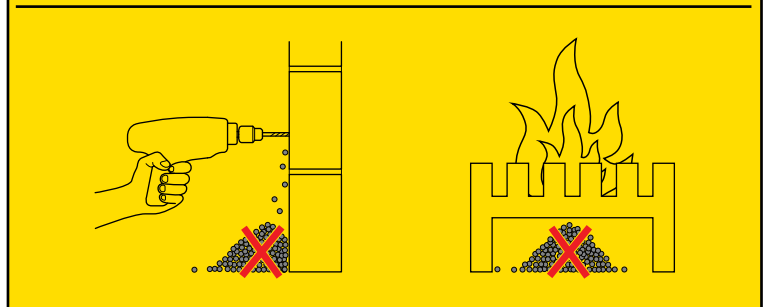

**REGISTER
YOUR FREE
5 YEAR
GUARANTEE
TODAY**

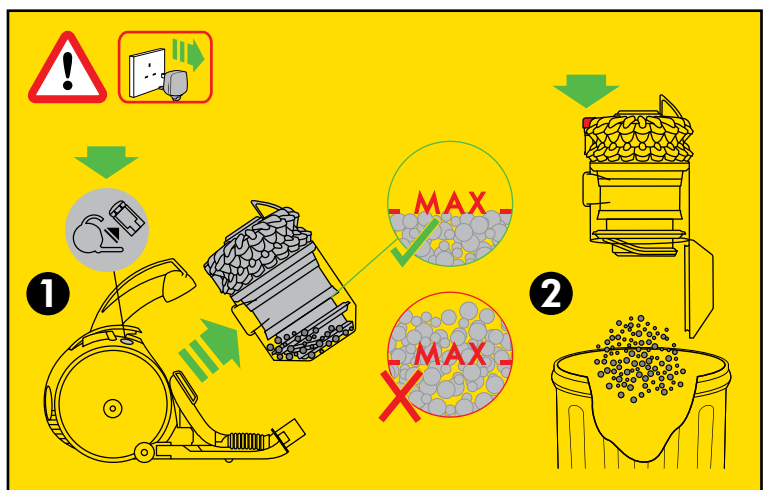
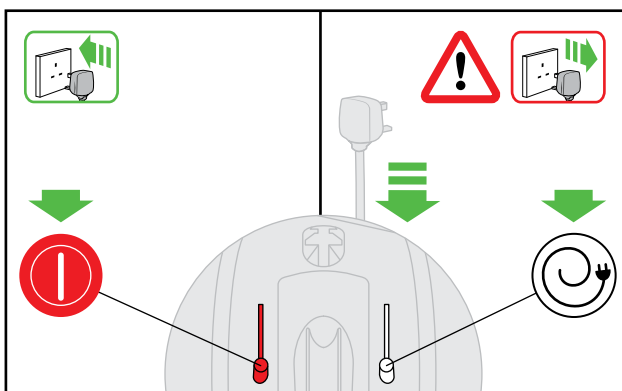
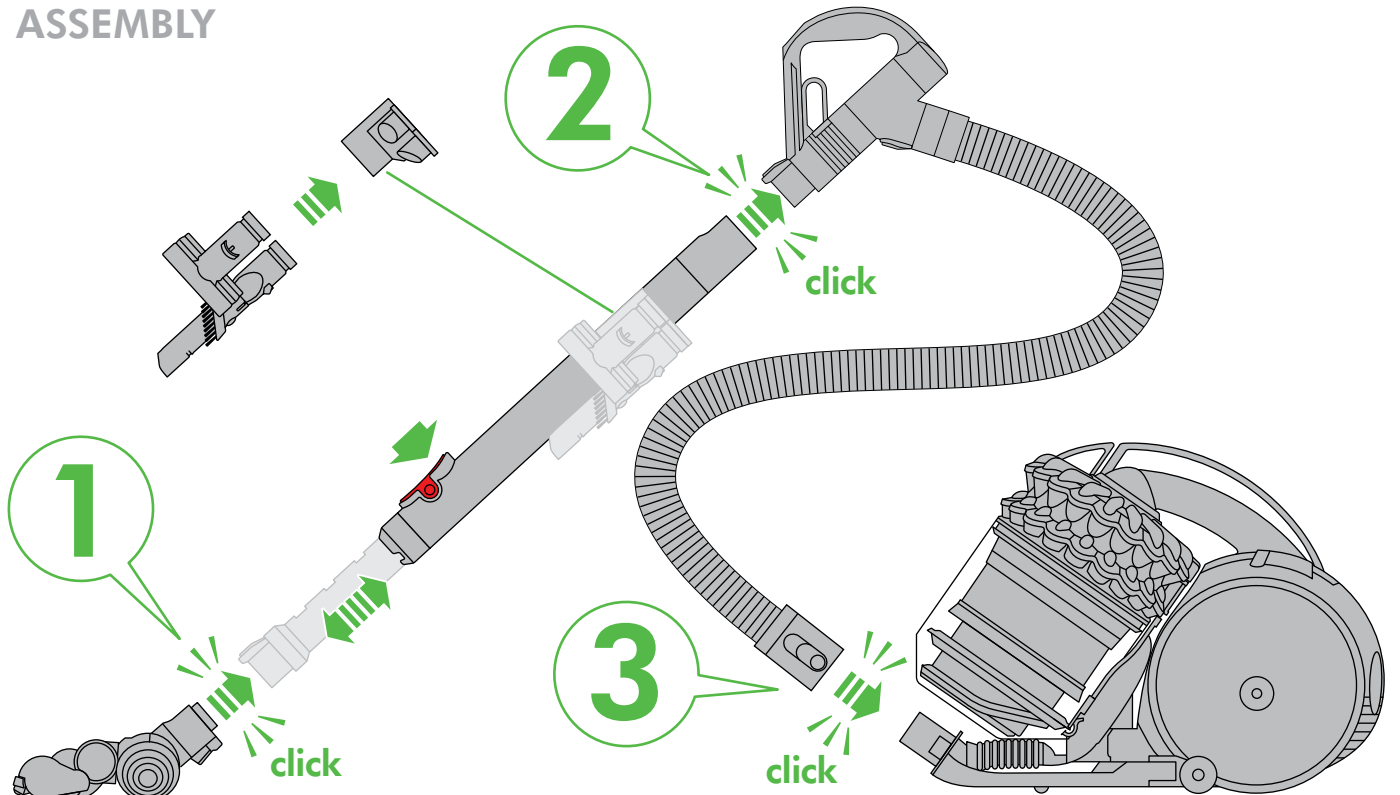

DYSON CUSTOMER CARE

THANK YOU FOR CHOOSING TO BUY A DYSON APPLIANCE

After registering your 5 year guarantee, your Dyson appliance will be covered for parts and labour for 5 years from the date of purchase, subject to the terms of the guarantee. If you have any questions about your Dyson appliance, call the Dyson Helpline with your serial number and details of where/when you bought the appliance. Most questions can be solved over the phone by one of our trained Dyson Helpline staff. Your serial number can be found on your rating plate which is on the base of the appliance. Alternatively, visit www.dyson.co.uk/support (UK) or www.dyson.ie/support (ROI) for online help, general tips and useful information about Dyson.

DYSON CONTACT DETAILS

UK:

Website: www.dyson.co.uk/support

Dyson Helpline: 0800 298 0298

Email: askdyson@dyson.co.uk

Address: Dyson Ltd, Tetbury Hill, Malmesbury,
Wiltshire, SN16 0RP

ROI:

Website: www.dyson.ie/support

Dyson Helpline: 01 475 7109

Email: askdyson@dyson.co.uk

Address: Dyson Ireland Limited, Unit G10, Grants Lane,
Greenogue Business Park, Rathcoole, Dublin 24

Note your serial number for future reference.



This illustration is for example purposes only.

3 EASY WAYS TO REGISTER YOUR FREE 5 YEAR GUARANTEE

REGISTER ONLINE

Visit our website to register your full parts and labour guarantee online.

www.dyson.co.uk/register
www.dyson.ie/register



REGISTER BY PHONE

Call our dedicated Helpline.
Open Monday to Friday
8am-8pm & Saturday and Sunday
8am-6pm.

UK: 0800 298 0298
ROI: 01 475 7109



REGISTER BY MAIL

Complete and return the form to
Dyson in the envelope supplied.

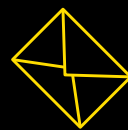

IMPORTANT SAFETY INSTRUCTIONS

BEFORE USING THIS APPLIANCE READ ALL INSTRUCTIONS AND CAUTIONARY MARKINGS IN THIS MANUAL AND ON THE APPLIANCE

When using an electrical appliance, basic precautions should always be followed, including the following:

WARNING

These warnings apply to the appliance, and also where applicable, to all tools, accessories, chargers or mains adaptors.

TO REDUCE THE RISK OF FIRE, ELECTRIC SHOCK, OR INJURY:

1. This Dyson appliance is not intended for use by young children or infirm persons with reduced physical, sensory or reasoning capabilities, or lack of experience and knowledge, unless they have been given supervision or instruction by a responsible person concerning use of the appliance to ensure that they can use it safely.
2. Do not allow to be used as a toy. Close attention is necessary when used by or near children. Children should be supervised to ensure that they do not play with the appliance.
3. Use only as described in this Dyson Operating Manual. Do not carry out any maintenance other than that shown in this manual, or advised by the Dyson Helpline.
4. Suitable for dry locations ONLY. Do not use outdoors or on wet surfaces.
5. Do not handle any part of the plug or appliance with wet hands.
6. Do not use with a damaged cable or plug. If the supply cable is damaged it must be replaced by Dyson, its service agent or similarly qualified person in order to avoid a hazard.
7. If the appliance is not working as it should, has received a sharp blow, has been dropped, damaged, left outdoors, or dropped into water, do not use and contact the Dyson Helpline.
8. Contact the Dyson Helpline when service or repair is required. Do not disassemble the appliance as incorrect reassembly may result in an electric shock or fire.
9. Do not stretch the cable or place the cable under strain. Keep the cable away from heated surfaces. Do not close a door on the cable, or pull the cable around sharp edges or corners. Arrange the cable away from traffic areas and where it will not be stepped on or tripped over. Do not run over the cable.
10. Do not unplug by pulling on the cable. To unplug, grasp the plug, not the cable. The use of an extension cable is not recommended.
11. Do not use to pick up water.
12. Do not use to pick up flammable or combustible liquids, such as petrol, or use in areas where they or their vapours may be present.
13. Do not pick up anything that is burning or smoking, such as cigarettes, matches, or hot ashes.
14. Keep hair, loose clothing, fingers, and all parts of the body away from openings and moving parts, such as the brush bar. Do not point the hose, wand or tools at your eyes or ears or put them in your mouth.
15. Do not put any object into openings. Do not use with any opening blocked; keep free of dust, lint, hair, and anything that may reduce airflow.
16. Use only Dyson recommended accessories and replacement parts.
17. To avoid a tripping hazard wind the cable when not in use.
18. Do not use without the clear bin and cyclone in place.
19. Do not leave the appliance when plugged in. Unplug when not in use and before servicing.
20. Do not pull or carry by cable or use cable as a handle.
21. Use extra care when cleaning on stairs. Do not work with the appliance above you on the stairs.
22. Turn off all controls before unplugging. Unplug before connecting any tool or accessory.
23. Always extend the cable to the red line but do not stretch or tug the cable.
24. Hold the plug when rewinding onto cable reel. Do not allow the plug to whip when rewinding.

READ AND SAVE THESE INSTRUCTIONS

THIS DYSON APPLIANCE IS INTENDED FOR HOUSEHOLD USE ONLY



Do not pull on the cable.

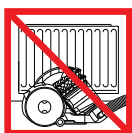

Do not store near heat sources.



Do not use near naked flames.

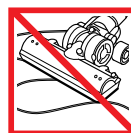

Do not run over the cable.



Do not pick up water or liquids.



Do not pick up burning objects.



Do not use above you on the stairs.



Do not put hands near the brush bar when the appliance is in use.

Power & cable

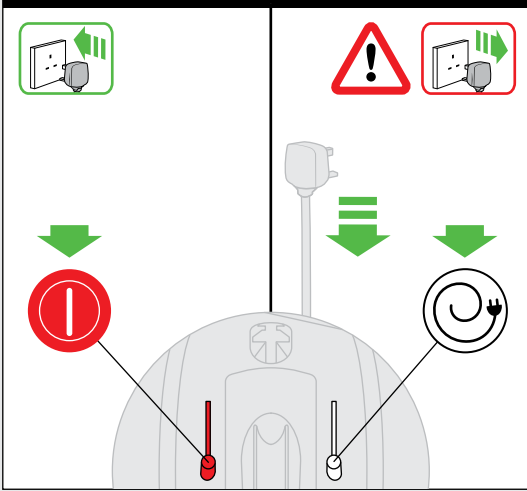

Cleaning the clear bin

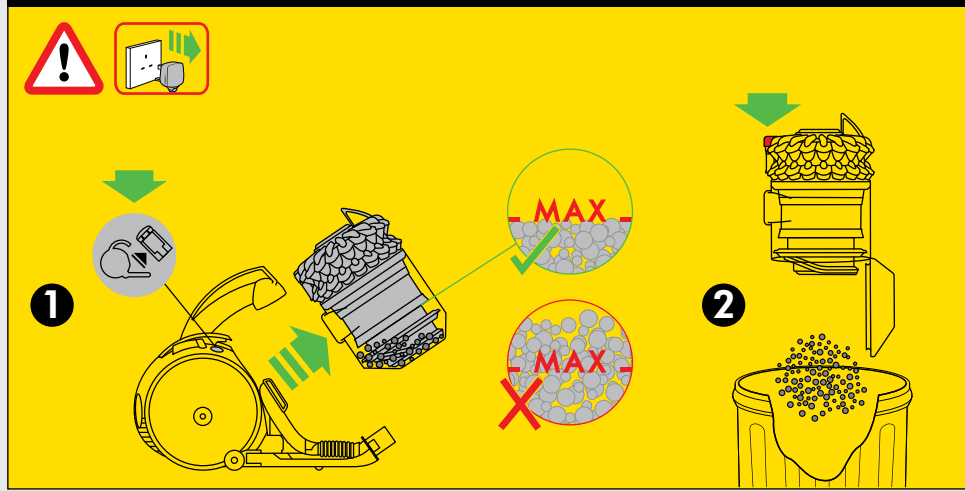

Brush bar – clearing obstructions

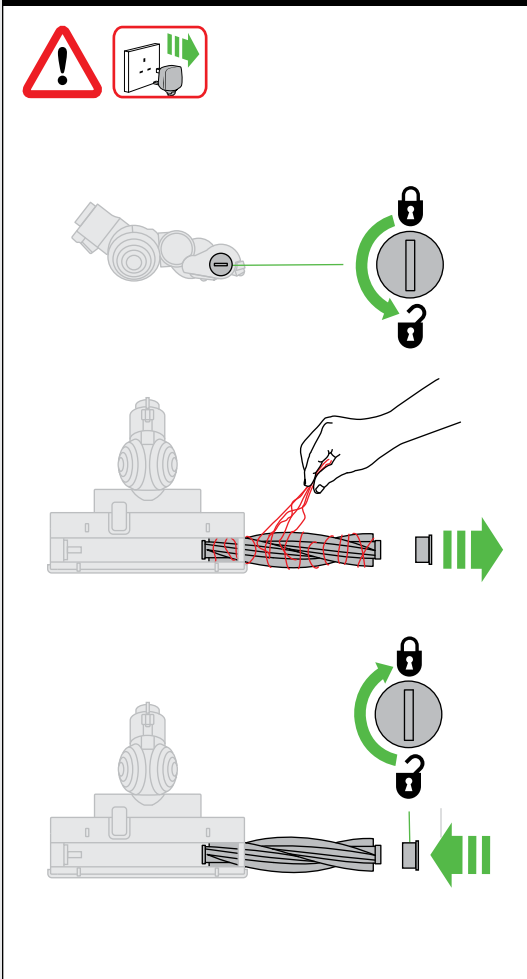

Tool attachments

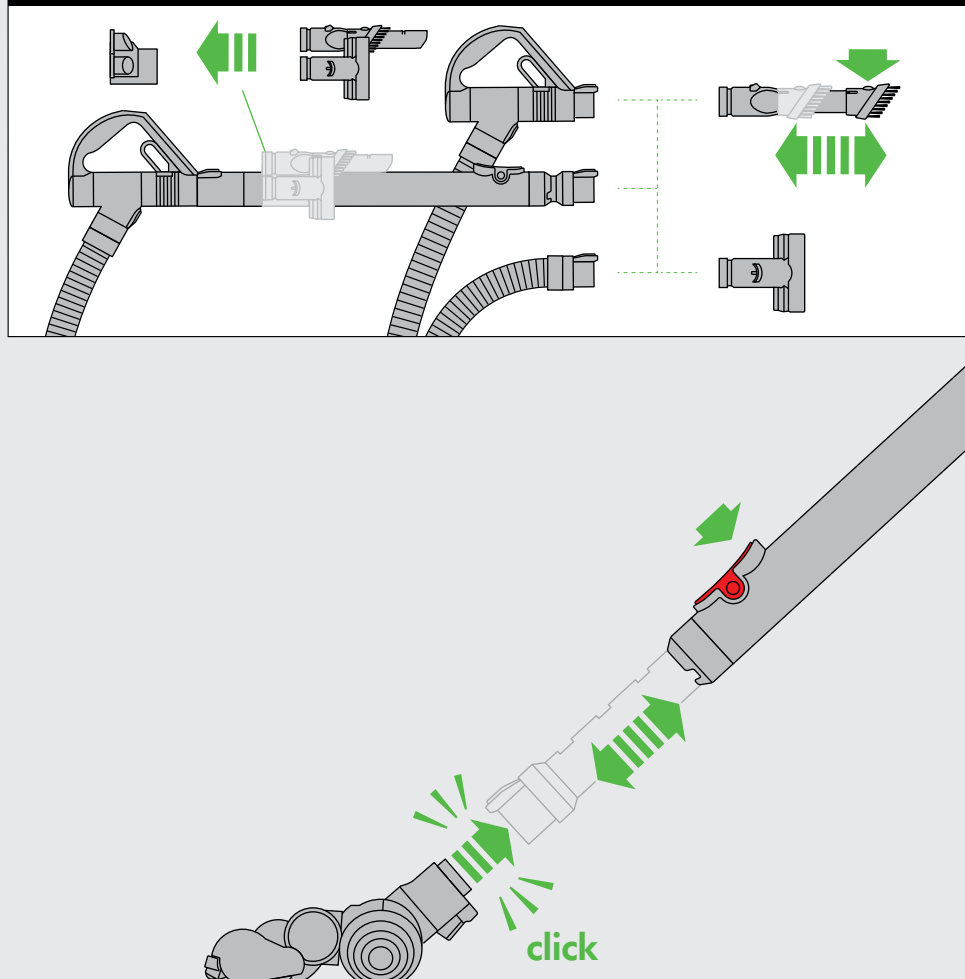

Looking for blockages

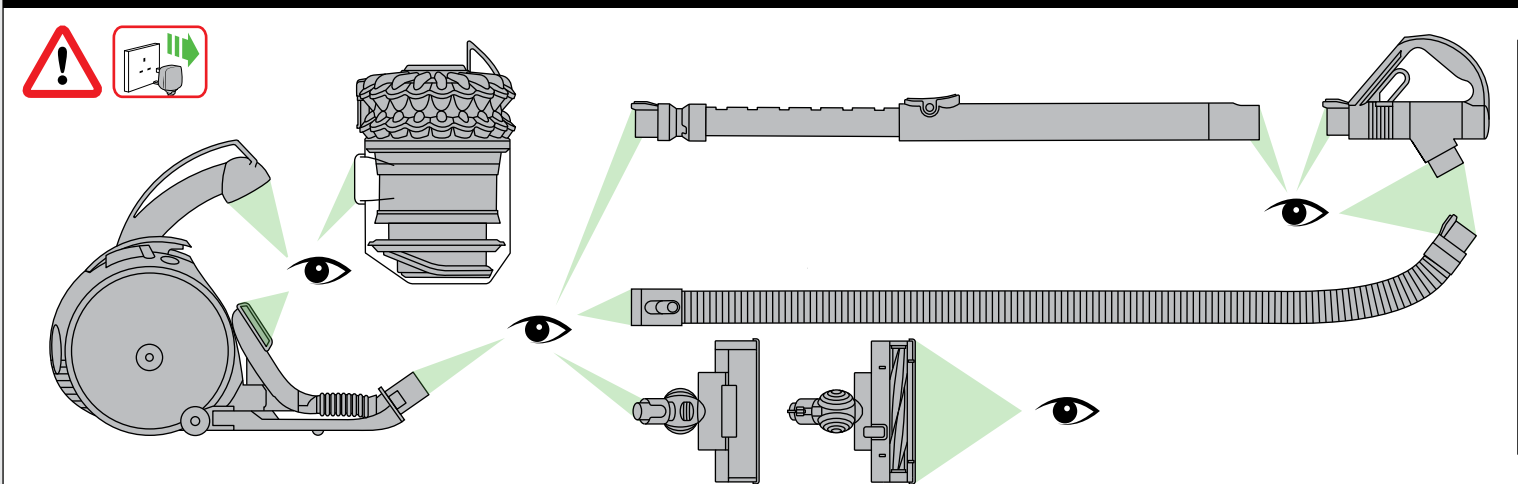

Cleaning the shroud

1

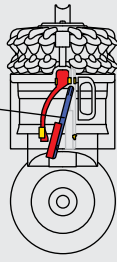
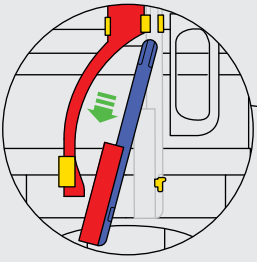

2

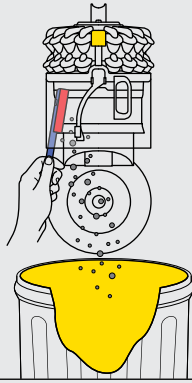

Suction release

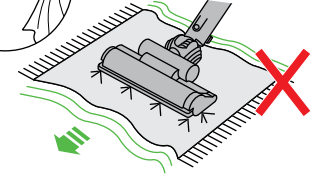
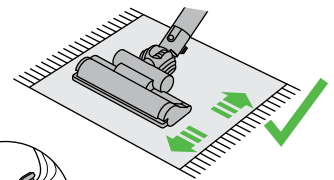
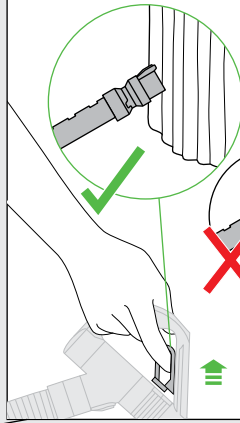

Carrying & storage

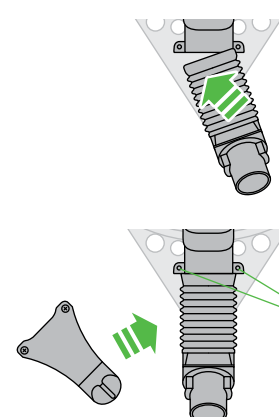
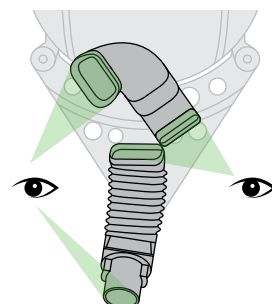
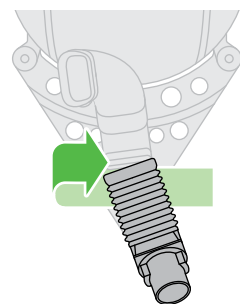
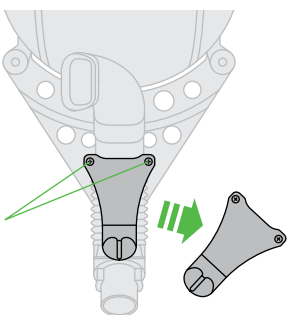
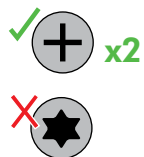
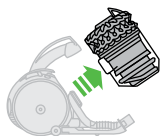
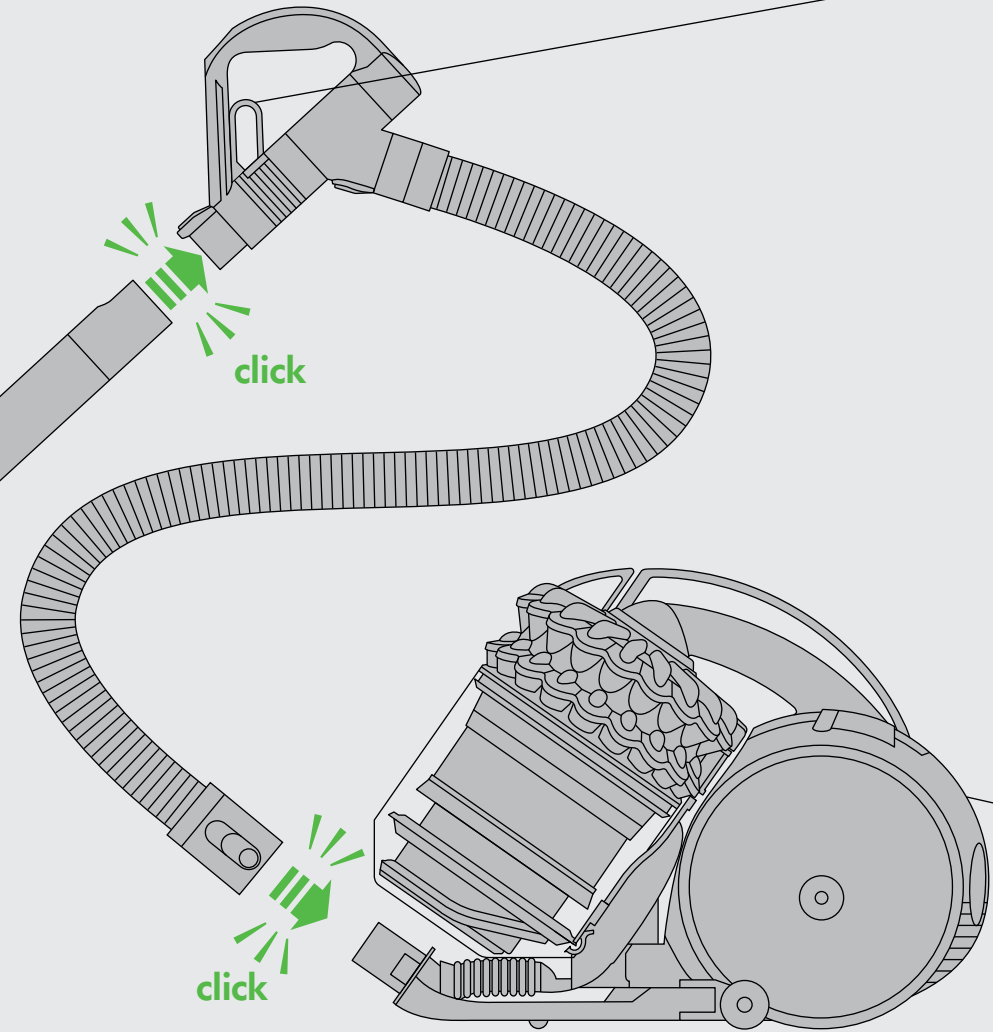
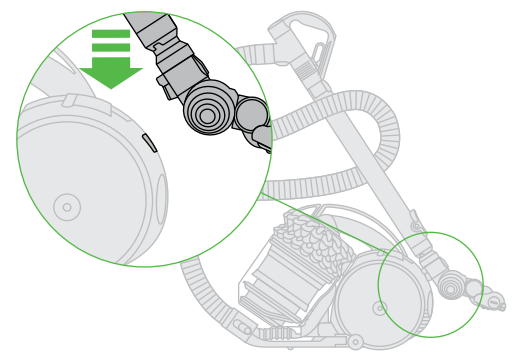
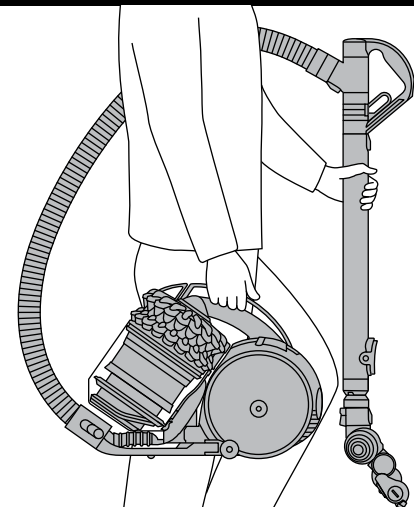

USING YOUR DYSON APPLIANCE

PLEASE READ THE 'IMPORTANT SAFETY INSTRUCTIONS' IN THIS DYSON OPERATING MANUAL BEFORE PROCEEDING.

CARRYING THE APPLIANCE

- Carry the appliance by the main handle on the body.
- Do not press the cyclone release button or shake the appliance when carrying or the cyclone could disengage, fall off and cause injury.

OPERATION

- Always extend the cable fully to the red tape before use.
- Plug the appliance into the mains electricity supply.
- To switch 'ON' or 'OFF' press the red power button, located as shown.
- After use: unplug, retract the cable safely, put the appliance away.
- Switch 'OFF' the appliance, unplug and ensure it is upright before:
 - changing or using tools
 - removing the hose or airway inspection parts.
- To watch a short online video visit:
 - UK – www.dyson.co.uk/dc54gettingstarted
 - ROI – www.dyson.ie/dc54gettingstarted

CARPETS OR HARD FLOORS

- The brush bar will always default to 'ON' (spinning) each time you switch the machine 'ON'.
- To reduce the speed of the brush bar (e.g. for delicate flooring and delicate hard floors), pull the suction release trigger on the handle.
- The brush bar will automatically stop if it becomes obstructed. See 'Brush bar – clearing obstructions'.
- Before vacuuming your flooring, rugs and carpets, check the manufacturer's recommended cleaning instructions.
- Some carpets may fuzz if a rotating brush bar is used when vacuuming. If this happens, we recommend pulling the suction release trigger to reduce brush bar spin.
- The brush bar on the machine may damage some carpet types and delicate hard flooring. If you are unsure, pull the suction release trigger to reduce brush bar spin. Alternatively, use a Dyson hard floor tool (available as an option).
- This product has carbon fibre brushes. Take care if coming into contact with them, as they may cause minor skin irritation. Wash your hands after handling the brushes.

LOOKING AFTER YOUR DYSON APPLIANCE

- Do not carry out any maintenance or repair work other than that shown in this Dyson Operating Manual, or advised by the Dyson Helpline.
- Only use parts recommended by Dyson. If you do not this could invalidate your guarantee.
- Store the appliance indoors. Do not use or store it below 3°C (37.4°F). Ensure the appliance is at room temperature before operating.
- Clean the appliance only with a dry cloth. Do not use any lubricants, cleaning agents, polishes or air fresheners on any part of the appliance.
- If used in a garage, always wipe the base plate and ball with a dry cloth after vacuuming to clean off any sand, dirt, or pebbles that could damage delicate floors.

VACUUMING

- Do not use without the clear bin and cyclone in place.
- Do not use on rubble, ash or plaster. This appliance is designed only for domestic use to remove household dirt, hair and allergens. The appliance is not designed to be used on:
 - debris produced from activities such as DIY, building or similar tasks
 - larger types and quantities of dust or debris, such as soot and sawdust.These materials may harm the appliance and may void your guarantee.
- Fine dirt such as flour should only be vacuumed in very small amounts.
- Do not use the appliance to pick up sharp hard objects, small toys, pins, paper clips, etc. They may damage the appliance.
- When vacuuming, certain carpets may generate small static charges in the clear bin or wand. These are harmless and are not associated with the mains electricity supply. To minimise any effect from this, do not put your hand or insert any object into the clear bin unless you have first emptied it and rinsed it out with cold water (see 'Cleaning the clear bin').
- Do not work with the appliance above you on the stairs.
- Do not put the appliance on chairs, tables, etc.
- Before vacuuming highly polished floors, such as wood or lino, first check that the underside of the floor tool and its brushes are free from foreign objects that could cause marking.
- Do not push hard with the floor tool when vacuuming, as this may cause damage.
- Do not leave the cleaner head in one place on delicate floors.
- On waxed floors the movement of the cleaner head may create an uneven lustre. If this happens, wipe with a damp cloth, polish the area with wax, and wait for it to dry.
- To reduce suction (for example, when vacuuming rugs), pull the suction release trigger on the handle to reduce the airflow.

EMPTYING THE CLEAR BIN

- Empty as soon as the dirt reaches the level of the MAX mark – do not overfill.
- Switch 'OFF' and unplug before emptying the clear bin.
- To remove the cyclone and clear bin unit, push the release button to the side of the carrying handle, as shown. The carrying handle will be released.
- To release the dirt, press the red bin release button.
- To minimise dust/allergen contact when emptying, encase the clear bin tightly in a plastic bag and empty.
- Remove the clear bin carefully from the bag.
- Seal the bag tightly, dispose as normal.
- Close the clear bin base so it clicks into place and is secure.
- Place the clear bin and cyclone unit into position on the front of the main body of the appliance. The recess in the base of the clear bin must fit onto the lug on the support bracket.

- Push the carrying handle down so it clicks into place on the top of the clear bin and cyclone unit. Ensure it is secure.
- For a free fact sheet visit: www.dyson.co.uk/technology/allergy

CLEANING THE CLEAR BIN

- Remove cyclone and clear bin (see 'Emptying the clear bin').
- To separate the cyclone from the clear bin press the red bin release button to open the bin base. This exposes a small silver button behind the red opening mechanism.
- Press the small silver button on the cyclone. Separate the cyclone from the clear bin.
- Clean the clear bin with cold water only.
- Do not use detergents, polishes or air fresheners to clean the clear bin.
- Do not put the clear bin in a dishwasher.
- Do not immerse the whole cyclone in water or pour water into the cyclones.
- Clean the cyclone shroud with a cloth or the provided brush to remove any lint and dust.
- Ensure the clear bin is completely dry before replacing.
- To replace, first close the clear bin base so it clicks into place and is secure.
- Fit the clear bin onto the cyclone. To secure it, first fit the slot on the front rim of the clear bin onto the lug on the front of the cyclone; then push the rear of the clear bin into place so the silver button engages and clicks into place.
- Fit the cyclone and clear bin unit onto the appliance (see 'Emptying the clear bin').

BLOCKAGES – THERMAL CUT-OUT

- This appliance is fitted with an automatically resetting thermal cut-out.
- If any part becomes blocked the appliance may overheat and automatically cut-out.
- If this happens, follow the instructions below in 'Looking for blockages'.
- NOTE: Large items may block the tools or wand inlet. If this happens, do not operate the wand release catch. Switch 'OFF' and unplug. Failure to do so could result in personal injury.

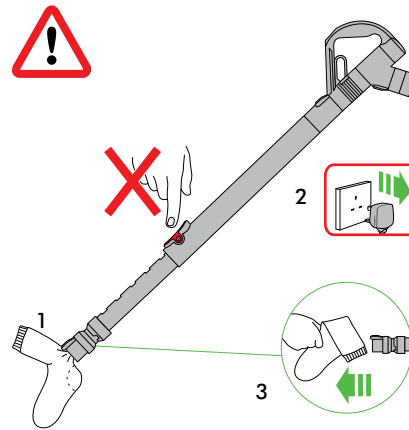

LOOKING FOR BLOCKAGES

- Switch 'OFF' and unplug before looking for blockages. Failure to do so could result in personal injury.
- Leave to cool down for 1-2 hours before looking for blockages.
- Beware of sharp objects when checking for blockages.
- To access the flexible inspection hose beneath the clear bin, first remove the clear bin (see above).
- Unscrew the two Phillips screws on the clear bin locator bracket. (Do not remove any other screws.) Remove the bracket.
- Firmly twist the flexible inspection hose away from the inlet next to the ball (do not remove the end next to the connection for the main hose).
- Inspect for blockages.
- Clear any blockage before restarting.
- Refit all parts securely before using.
- Clearing blockages is not covered by your guarantee.

BRUSH BAR – CLEARING OBSTRUCTIONS

- If your brush bar is obstructed, it may shut 'OFF'. If this happens you will need to remove the brush bar as shown.
- Switch 'OFF' and unplug before proceeding. Failure to do so could result in personal injury.
- Remove the brush bar by using a coin to loosen the fastener marked with a padlock until it clicks.
- Beware of sharp objects when clearing obstructions.
- Replace the brush bar and secure it by tightening the fastener until it clicks. Ensure it is fixed firmly before operating.
- Clearing brush bar obstructions is not covered by your guarantee.
- This product has carbon fibre brushes. Take care if coming into contact with them, as they may cause minor skin irritation. Wash your hands after handling the brushes.

BRUSH BAR – TROUBLESHOOTING

- If the brush bar has stopped spinning, follow the instructions above on clearing obstructions. Alternatively, contact a Dyson expert on the Dyson Helpline or visit the website.

DISPOSAL INFORMATION

- Dyson products are made from high grade recyclable materials. Recycle where possible.

GUARANTEE TERMS AND CONDITIONS

DYSON CUSTOMER CARE

THANK YOU FOR CHOOSING TO BUY A DYSON APPLIANCE

After registering your 5 year guarantee, your Dyson appliance will be covered for parts and labour for 5 years from the date of purchase, subject to the terms of the guarantee. If you have any questions about your Dyson appliance, call the Dyson Helpline with your serial number and details of where/when you bought the appliance. Most questions can be solved over the phone by one of our trained Dyson Helpline staff.

Alternatively, visit www.dyson.com for online help, general tips and useful information about Dyson.

If your Dyson appliance needs a service, call the Dyson Helpline so we can discuss the available options. If your Dyson appliance is under guarantee, and the repair is covered, it will be repaired at no cost.

Your serial number can be found on your rating plate which is on the base of the appliance.

PLEASE REGISTER AS A DYSON APPLIANCE OWNER

To help us ensure you receive prompt and efficient service, please register as a Dyson appliance owner. There are three ways to do this:

- Online at www.dyson.co.uk/register (UK) or www.dyson.ie/support (ROI).
 - Telephone the Dyson Helpline.
 - Complete the enclosed form and post it to us.
- This will confirm ownership of your Dyson appliance in the event of an insurance loss, and enable us to contact you if necessary.

LIMITED 5 YEAR GUARANTEE

TERMS AND CONDITIONS OF THE DYSON 5 YEAR LIMITED GUARANTEE.

WHAT IS COVERED

- The repair or replacement of your Dyson appliance (at Dyson's discretion) if it is found to be defective due to faulty materials, workmanship or function within 5 years of purchase or delivery (if any part is no longer available or out of manufacture Dyson will replace it with a functional replacement part).
- Where this appliance is sold outside of the EU, this guarantee will only be valid if the appliance is used in the country in which it was sold.
- Where this appliance is sold within the EU, this guarantee will only be valid (i) if the appliance is used in the country in which it was sold or (ii), if the appliance is used in Austria, Belgium, France, Germany, Ireland, Italy, Netherlands, Spain or the United Kingdom and the same model as this appliance is sold at the same voltage rating in the relevant country.

WHAT IS NOT COVERED

Dyson does not guarantee the repair or replacement of a product where a defect is the result of:

- Accidental damage, faults caused by negligent use or care, misuse, neglect, careless operation or handling of the appliance which is not in accordance with the Dyson Operating Manual.
- Use of the appliance for anything other than normal domestic household purposes.
- Use of parts not assembled or installed in accordance with the instructions of Dyson.
- Use of parts and accessories which are not genuine Dyson components.
- Faulty installation (except where installed by Dyson).
- Repairs or alterations carried out by parties other than Dyson or its authorised agents.
- Blockages – please refer to the Dyson Operating Manual for details of how to look for and clear blockages.
- Normal wear and tear (e.g. fuse, brush bar etc.).
- Use of this appliance on rubble, ash, plaster.
- Reduction in battery discharge time due to battery age or use (where applicable).

If you are in any doubt as to what is covered by your guarantee, please contact Dyson.

SUMMARY OF COVER

- The guarantee becomes effective at the date of purchase (or the date of delivery if this is later).
- You must provide proof of (both the original and any subsequent) delivery/purchase before any work can be carried out on your Dyson appliance. Without this proof, any work carried out will be chargeable. Keep your receipt or delivery note.
- All work will be carried out by Dyson or its authorised agents.
- Any parts which are replaced by Dyson will become the property of Dyson.
- The repair or replacement of your Dyson appliance under guarantee will not extend the period of guarantee.
- The guarantee provides benefits which are additional to and do not affect your statutory rights as a consumer.

ABOUT YOUR PRIVACY

- Your information will be held by Dyson and its agents for promotional, marketing and servicing purposes.
- If your personal details change, if you change your mind about any of your marketing preferences or if you have any queries about how we use your information, please contact Dyson.
- For more information on how we protect your privacy, please see our privacy policy on the Dyson website.



Dyson Customer Care

If you have a question about your Dyson appliance, call the Dyson Customer Care Helpline with your serial number and details of where and when you bought the appliance, or contact us via the Dyson website.

DYSON CONTACT DETAILS

UK:

Website: www.dyson.co.uk/support

Dyson Helpline: 0800 298 0298

Email: askdyson@dyson.co.uk

Address: Dyson Ltd, Tetbury Hill, Malmesbury, Wiltshire,
SN16 0RP

ROI:

Website: www.dyson.ie/support

Dyson Helpline: 01 475 7109

Email: askdyson@dyson.co.uk

Address: Dyson Ireland Limited, Unit G10, Grants Lane,
Greenogue Business Park, Rathcoole, Dublin 24



Serial number

Date of purchase / / Country of purchase UK ROI

Title Surname

First name

Address

Postcode

e-mail

Telephone Mobile

As a Dyson vacuum cleaner owner, you can hear about Dyson inventions, services and products before anyone else. If it's okay to contact you, please let us know how we may do this.

By mail Yes No

By phone Yes No

By email Yes No

By text message Yes No

We sometimes ask other companies (such as market researchers) to contact owners on our behalf. We do this to get feedback on ideas or ask you to try new products and services. Would this be okay?

Yes No

3 EASY WAYS TO REGISTER YOUR FREE 5 YEAR GUARANTEE

REGISTER ONLINE 

Visit our website to register your full parts and labour guarantee online.

www.dyson.co.uk/register
www.dyson.ie/register

REGISTER BY PHONE 

Call our dedicated Helpline. Open Monday to Friday 8am-8pm & Saturday and Sunday 8am-6pm.

UK: 0800 298 0298
ROI: 01 475 7109

REGISTER BY MAIL 

Complete and return the form to Dyson in the envelope supplied.

